



TIBOX[®]
TIANQI ELECTRIC

TIBOX[®]
TIANQI ELECTRIC



dream

Tianqi Electric is com
world's leading power



Cooperation

Tianqi electric solidarity, to create first-class products



Sincerity

Tianqi electric adheres to inte

About us

Committed to build the
distribution system



浙江天齐电气有限公司，成立于1998年，是一家集研发、生产、工程、销售成套电器中外合资企业。公司注册资本1288万美元，生产区占地210余亩、建筑面积50000平方米，现有员工400余人。公司总部、生产中心位于以“中国第一生态县”著称的浙江安吉县天子湖工业园区，同时在上海设立营销分部。

公司拥有德国先进的激光切割设备、数控机床、多功能成型设备和密封设备，产品远销东南亚、欧美等国家和地区，用户遍布世界各地。目前主要产品：成套电器金属机柜、挂式机柜、落地式机柜、网络机柜、总线接线盒、塑料机柜及塑料防水防尘接线盒、塑料密封盒等高端技术产品。公司现已通过ISO9001、ISO14001管理体系认证；其中ST序列金属机柜多款产品通过UL、IP66、ROHS、TUV、CE、CB等系列认证，并获得国家仪（板）表产品生产许可证。

公司坚持“以科技为导向、以质量求发展”为经营理念，坚持为新老客户打造优质的产品、以优惠的价格，快捷的供货渠道、完善的售后服务赢得客户的信任；坚持“以人为本、人尽其才”的用人理念，大力吸收、培养专业化的经营管理团队，不断提升企业管理和技术创新水平；公司注重人文关怀和绿色环保，为全体员工努力创造舒适的工作和生活环境。

海纳百川、心诚志远，如今浙江天齐电气公司在业内已具备强大的综合竞争实力和可持续发展能力，并着手进军更广阔的经营领域。公司在实现自身发展的同时，有力推进了当时经济的发展，更以其对社会的高度责任和回馈，赢得了当地政府和社会各界的一致好评。

WE with 17 years experience in electrical industry, is one of the leading manufacturers of distribution boxes in china. Founded in china 1998, located in the beautiful land scape of the largest china Bamboo Sea is in the north of Zhejiang province, covers an area of 66,000 square metres and has 400 employees. The company has got the national quality system certificate of ISO9001 and also received warm welcome in its circle. Our ISO 9001:2758 and ISO 14001:2754-certificated factory is equipped with seven production lines, which allow us to supply up to 6000 pieces every month. The company also got OHSAS 18001:2007 of occupational health and safety management systems.

We offer 400 different products for our clients to choose from. And our engineers add 5 to 10 new items to this variety every year. We can also develop a new product according to your special requests within 40 days.

Our trained staff work on imported production equipment, and we have over 20 QC personnel to strictly inspect our products, which carry CE and ROHS marks, and are SGS- and TUV-inspected. We export to buyers in the US, Canada, South America, southeast Asia, the Middle East, India, Africa and other countries and regions. For delivery, you can expect to get your order in 30 to 60 days, depending upon the quantity. E-mail us today

Integrity with professionalism



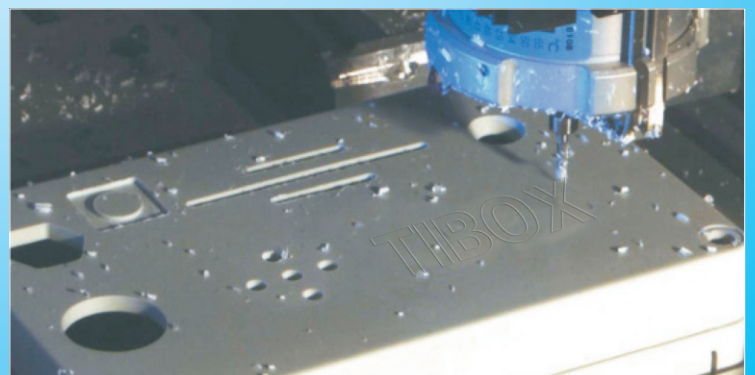
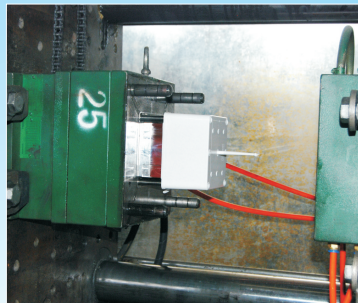
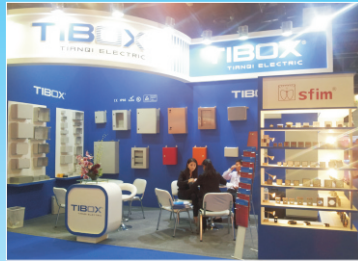

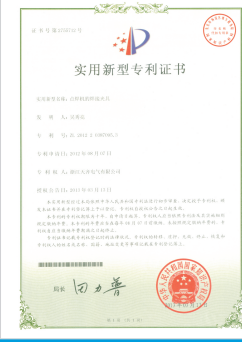
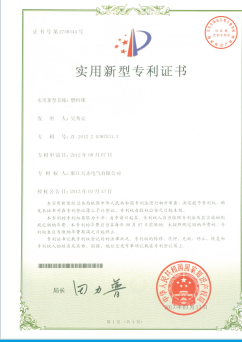
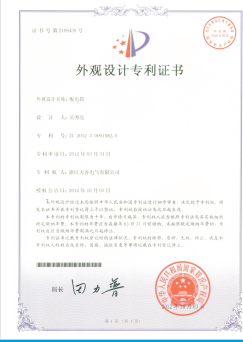
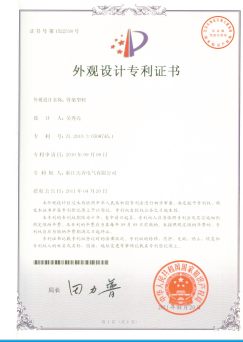
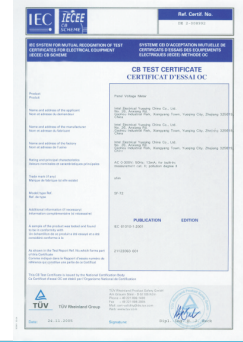
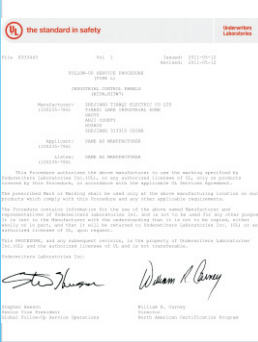
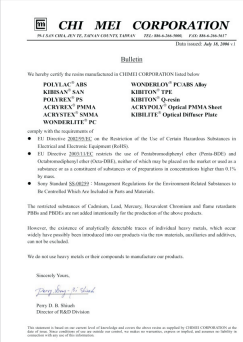
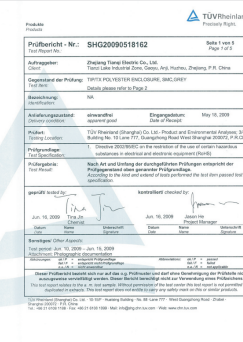
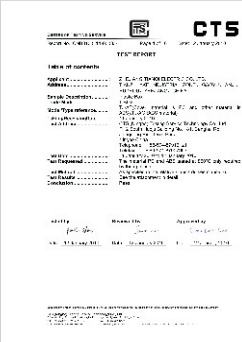
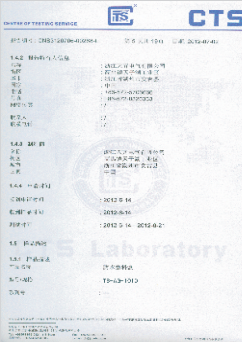
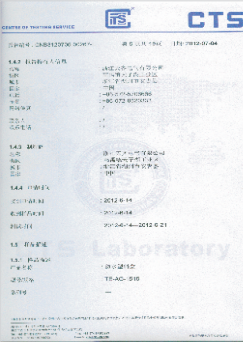
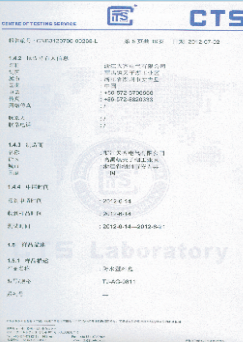

TIBOX®

TIANQI ELECTRIC

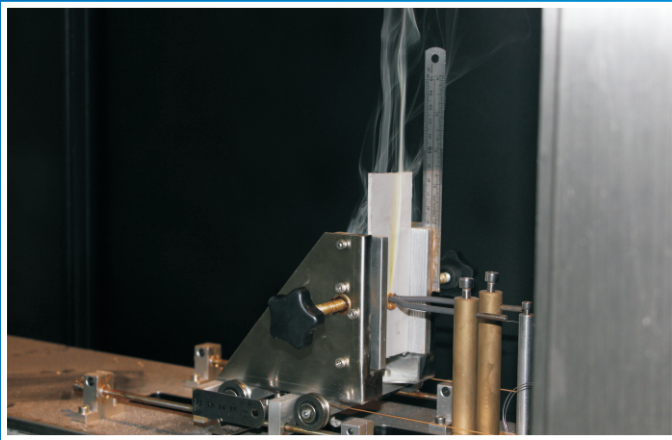
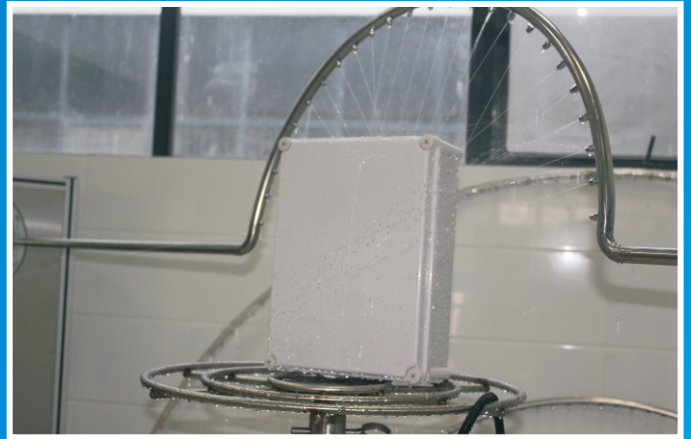
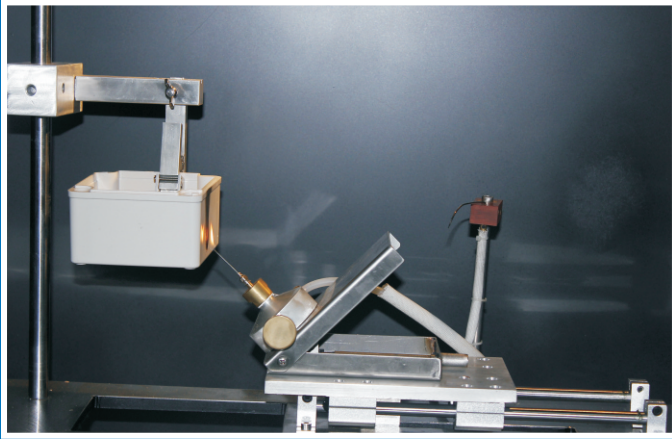





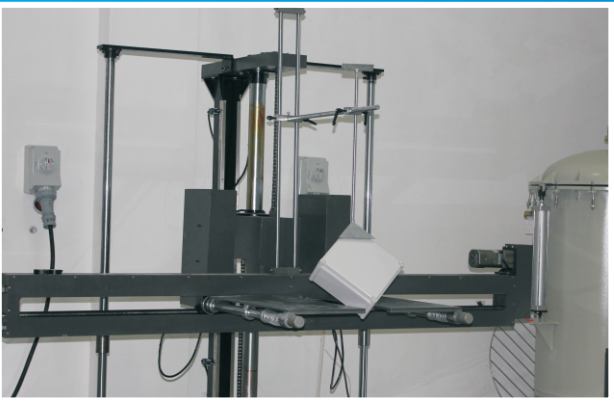
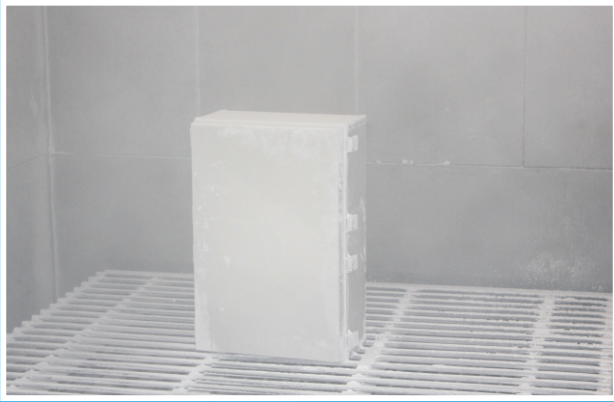





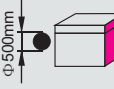

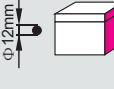





产品防护等级及耐候测试实验室

Product protection class and weathering test lab



TIBOX IP.IK 保护等级 Tibox Ingress Protection Grade

Protection class of enclosure in accordance with EN 60592,EN50102 standard

1 FIRST NUMBER	固体保护程度 Protection against solid	2 SECOND NUMBER	液体保护程度 Protection against liquids	IK CODE	冲击保护 Protection against mechanical impact
IP	测试 (TEST)	IP	测试 (TEST)	IK	测试 (TEST)
0	———— No protection	0	———— No protection	00	———— No protection
1	 对50mm以上固体有保护 Protected against solid objects up to 50mm	1	 竖直注水保护 Protected against vertically falling drops water	01-05	 冲击<1 joule Impact<1 joule
2	 对12mm以上固体有保护 Protected against solid objects up to 12mm	2	 15° 角度注水有保护 Protected against vertically falling drops water when enclosure tilted up to 15	06	 冲击=1 joule Impact=1 joule
3	 对2.5mm以上固体有保护 Protected against solid objects up to 2.5mm	3	 60° 角度注水有保护 Protected against vertically falling drops water when enclosure tilted up to 60	07	 冲击=2 joule Impact=2 joule
4	 对1mm以上固体有保护 Protected against solid objects up to 1mm	4	 任何方向注水有保护 Protected against splashing water	08	 冲击=5 joule Impact=5 joule
5	 对灰尘以外固体有保护 Protected against dust limited ingress	5	 任何方向低压注水有保护 Protected against low pressure jets of water from all directions limited ingress	09	 冲击=10 joule Impact=10 joule
6	 对固体完全保护, 包括灰尘 Totally protected against dust	6	 任何方向高压注水有保护 Protected against water jets	10	 冲击=20 joule Impact=20 joule
		7	 15cm-1m深度完全浸入水中30分钟有保护 Protected against the effect of immersion between 15cm and 1m		
		8	 长期完全浸水有保护 Protected against long periods of immersion under pressure		

雄关漫道真如铁，而今迈步从头越。我们深知成功的来之不易，面对新时期的
机遇与挑战我们将不断的
用我们的激情和智慧去实现我们的理想。浙江天齐电气全体员工也会以更加饱满的热情，更为细致的工作为我们的广大用户提供更优质的服务。我们坚信，有您的同行，我们的明天会更好。

不同材料机箱有不同的机械强度 以及适应不同的工作环境

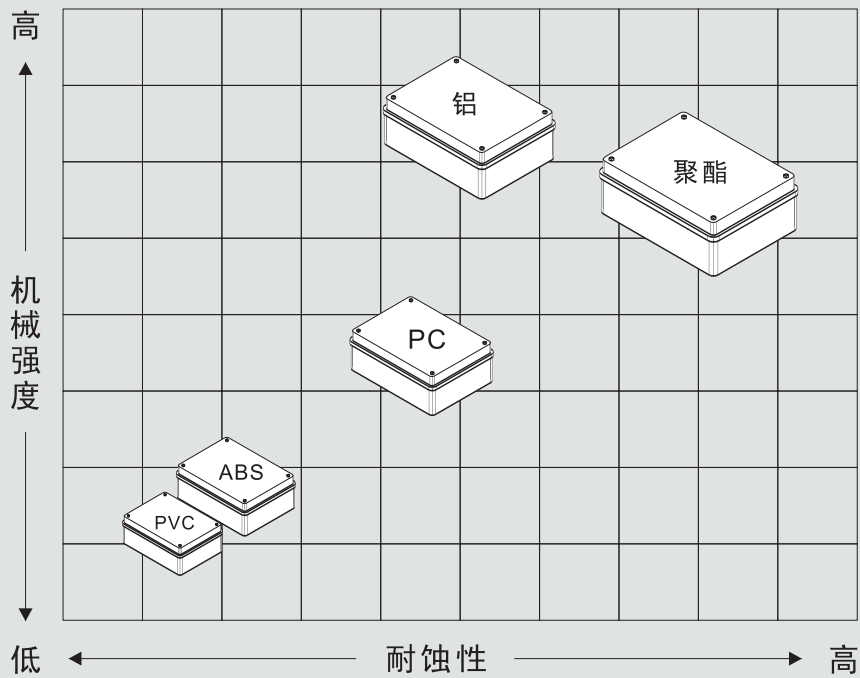

TJ系列 塑料盒(螺栓型)

TJ Series Plastic Enclosure (Screw type)



Dimension(允许误差 ± 1mm)

BASE

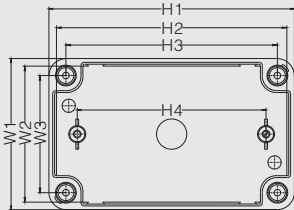

COVER
BASE

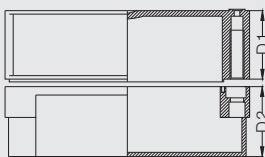

COVER
+BASE

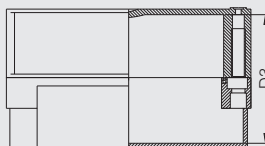

MOUNTING
PLATE

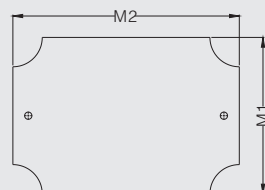

Size	Division	W ₁	W ₂	W ₃	H ₁	H ₂	H ₃	H ₄	D ₁	D ₂	D ₃	
★	50 × 65 × 55	50	44	37	65	59	52	40	20	35	30	
	65 × 95 × 55	65	59	50	95	89	79	50	15	40	40	
	75 × 125 × 75	75	66	56	125	116	107	90	25	50	60	
	75 × 125 × 100	75	66	46	125	116	107	90	50	50	85	
	80 × 80 × 60	80	77	62	80	77	62	50	15	45	45	
	80 × 110 × 45	80	72	62	110	102	92	80	20	25	28	
	80 × 110 × 60	80	72	62	110	102	92	80	35	25	42	
	80 × 110 × 70	80	72	62	110	102	92	80	20	50	52	
	80 × 110 × 85	80	72	62	110	102	92	80	35	50	68	
	80 × 130 × 70	80	72	62	130	122	112	100	20	50	52	
	80 × 130 × 85	80	72	62	130	122	112	100	35	50	68	
★	★	80 × 160 × 55	80	76	66	160	156	146	138	15	40	38
★	80 × 160 × 90	80	76	66	160	156	146	138	15	75	72	
	80 × 180 × 70	80	72	62	180	172	162	150	20	50	52	
	80 × 180 × 85	80	72	62	180	172	162	150	35	50	68	
	80 × 250 × 70	80	72	62	250	242	232	220	20	50	52	
	80 × 250 × 85	80	72	62	250	242	232	220	35	50	60	
	100 × 100 × 75	100	89	82	100	89	82	60	20	55	60	
	125 × 125 × 75	125	117	105	125	117	105	70	20	55	58	
	125 × 125 × 100	125	117	105	125	117	105	70	20	80	82	
	125 × 175 × 75	125	117	105	175	167	156	140	25	50	58	
	125 × 175 × 100	125	117	105	175	167	156	140	50	50	82	
	120 × 200 × 75	120	108	103	200	190	182	160	20	55	65	
	140 × 170 × 95	140	132	122	170	162	152	130	20	75	76	
	140 × 230 × 95	140	132	122	230	222	212	190	20	75	76	
	150 × 200 × 75	150	140	132	200	192	182	160	20	55	58	
	150 × 200 × 100	150	140	132	200	192	182	160	20	80	82	
	150 × 200 × 130	150	140	132	200	192	182	160	50	80	112	
	150 × 250 × 100	150	142	132	250	242	232	210	20	80	82	
	150 × 250 × 130	150	142	132	250	242	232	210	50	80	112	
	175 × 175 × 75	175	167	156	175	167	156	140	25	50	60	
	175 × 175 × 100	175	167	156	175	167	156	140	50	50	85	
	175 × 250 × 75	175	166	156	250	242	232	214	25	50	60	
	175 × 250 × 100	175	166	156	250	242	232	214	50	50	85	
	180 × 250 × 100	180	170	155	250	239	225	216	15	85	86	
	200 × 200 × 95	200	192	182	200	192	182	120	20	75	77	
	200 × 200 × 130	200	192	182	200	192	182	120	50	80	112	
	200 × 250 × 100	200	190	178	250	240	228	215	25	75	82	

防水防尘等级 IP 66

温度范围 -40°C~+80°C

备注

前面带★表示螺丝是不锈钢材质

TJ Series Plastic Enclosure(Screw type)

产品特征 Product characteristics



CE IP66



有极好的绝缘性能, 抗化学腐蚀和抗机械挤压的性能。达到高要求的IP66防护等级, 所有的箱体都防尘、防水、抗80° 高温。采用ABS、PC等材料制成, 外形美观、性能坚固。产品适用于小型终端机、按钮盒、信号机、继电器、计量器、通信用接线盒等设备。

The enclosure is according to EN60529 standard, free from corrosion, compressive property and insulation, widely used in electronics, communications, fire fighting apparatus, control panel terminal boxes, public accommodation, ship industry, food industry etc. we always give top priority to quality and safety, your satisfaction is guaranteed.

型号规格 Model and size

Size W H D	产品型号 Product model (Screw type)				内板型号 Plate Model		金属内板规格 Plate Size	
	ABS	PC/ABS	PC	PC	Plastic(塑料)	Metal(金属)	M1	M2
	盖:灰色ABS 盒体:灰色ABS Cover:Grey ABS Body:Grey ABS	盖:透明PC 盒体:灰色ABS Cover:Transparent PC Body:Grey ABS	盖:灰色PC 盒体:灰色PC Cover:Grey PC Body:Grey PC	盖:透明PC 盒体:灰色PC Cover:Transparent PC Body:Grey PC				
50 x 65 x 55	TJ-AG-0506	TJ-AT-0506	TJ-PG-0506	TJ-PT-0506	—	TJ-0506	40	55
65 x 95 x 55	TJ-AG-0609	TJ-AT-0609	TJ-PG-0609	TJ-PT-0609	—	—	—	—
75 x 125 x 75	TJ-AG-0712	TJ-AT-0712	TJ-PG-0712	TJ-PT-0712	TJ-0712P	TJ-0712	60	110
75 x 125 x 100	TJ-AG-0712-1	TJ-AT-0712-1	TJ-PG-0712-1	TJ-PT-0712-1	TJ-0712P	TJ-0712	60	110
80 x 80 x 60	TJ-AG-0808	TJ-AT-0808	TJ-PG-0808	TJ-PT-0808	—	TJ-0808	65	65
80 x 110 x 45	TJ-AG-0811-S	TJ-AT-0811-S	TJ-PG-0811-S	TJ-PT-0811-S	TJ-0811P	TJ-0811	67	91
80 x 110 x 60	TJ-AG-0811-1S	TJ-AT-0811-1S	TJ-PG-0811-1S	TJ-PT-0811-1S	TJ-0811P	TJ-0811	67	91
80 x 110 x 70	TJ-AG-0811	TJ-AT-0811	TJ-PG-0811	TJ-PT-0811	TJ-0811P	TJ-0811	67	91
80 x 110 x 85	TJ-AG-0811-1	TJ-AT-0811-1	TJ-PG-0811-1	TJ-PT-0811-1	TJ-0811P	TJ-0811	67	91
80 x 130 x 70	TJ-AG-0813	TJ-AT-0813	TJ-PG-0813	TJ-PT-0813	TJ-0813P	TJ-0813	67	117
80 x 130 x 85	TJ-AG-0813-1	TJ-AT-0813-1	TJ-PG-0813-1	TJ-PT-0813-1	TJ-0813P	TJ-0813	67	117
80 x 160 x 55	TJ-AG-0816-S	TJ-AT-0816-S	TJ-PG-0816-S	TJ-PT-0816-S	TJ-0816P	TJ-0816	67	151
80 x 160 x 90	TJ-AG-0816	TJ-AT-0816	TJ-PG-0816	TJ-PT-0816	TJ-0816P	TJ-0816	67	151
80 x 180 x 70	TJ-AG-0818	TJ-AT-0818	TJ-PG-0818	TJ-PT-0818	TJ-0818P	TJ-0818	70	170
80 x 180 x 85	TJ-AG-0818-1	TJ-AT-0818-1	TJ-PG-0818-1	TJ-PT-0818-1	TJ-0818P	TJ-0818	70	170
80 x 250 x 70	TJ-AG-0825	TJ-AT-0825	TJ-PG-0825	TJ-PT-0825	TJ-0825P	TJ-0825	67	237
80 x 250 x 85	TJ-AG-0825-1	TJ-AT-0825-1	TJ-PG-0825-1	TJ-PT-0825-1	TJ-0825P	TJ-0825	67	237
100 x 100 x 75	TJ-AG-1010	TJ-AT-1010	TJ-PG-1010	TJ-PT-1010	—	TJ-1010	80	80
125 x 125 x 75	TJ-AG-1212-S	TJ-AT-1212-S	TJ-PG-1212-S	TJ-PT-1212-S	TJ-1212P	TJ-1212	112	112
125 x 125 x 100	TJ-AG-1212	TJ-AT-1212	TJ-PG-1212	TJ-PT-1212	TJ-1212P	TJ-1212	112	112
125 x 175 x 75	TJ-AG-1217	TJ-AT-1217	TJ-PG-1217	TJ-PT-1217	TJ-1217P	TJ-1217	112	162
125 x 175 x 100	TJ-AG-1217-1	TJ-AT-1217-1	TJ-PG-1217-1	TJ-PT-1217-1	TJ-1217P	TJ-1217	112	162
120 x 200 x 75	TJ-AG-1220	TJ-AT-1220	TJ-PG-1220	TJ-PT-1220	—	TJ-1220	95	175
140 x 170 x 95	TJ-AG-1417	TJ-AT-1417	TJ-PG-1417	TJ-PT-1417	TJ-1417P	TJ-1417	127	154
140 x 230 x 95	TJ-AG-1423	TJ-AT-1423	TJ-PG-1423	TJ-PT-1423	TJ-1423P	TJ-1423	125	215
150 x 200 x 75	TJ-AG-1520-S	TJ-AT-1520-S	TJ-PG-1520-S	TJ-PT-1520-S	TJ-1520P	TJ-1520	136	185
150 x 200 x 100	TJ-AG-1520	TJ-AT-1520	TJ-PG-1520	TJ-PT-1520	TJ-1520P	TJ-1520	136	185
150 x 200 x 130	TJ-AG-1520-1	TJ-AT-1520-1	TJ-PG-1520-1	TJ-PT-1520-1	TJ-1520P	TJ-1520	136	185
150 x 250 x 100	TJ-AG-1525	TJ-AT-1525	TJ-PG-1525	TJ-PT-1525	TJ-1525P	TJ-1525	135	235
150 x 250 x 130	TJ-AG-1525-1	TJ-AT-1525-1	TJ-PG-1525-1	TJ-PT-1525-1	TJ-1525P	TJ-1525	135	235
175 x 175 x 75	TJ-AG-1717	TJ-AT-1717	TJ-PG-1717	TJ-PT-1717	TJ-1717P	TJ-1717	159	159
175 x 175 x 100	TJ-AG-1717-1	TJ-AT-1717-1	TJ-PG-1717-1	TJ-PT-1717-1	TJ-1717P	TJ-1717	159	159
175 x 250 x 75	TJ-AG-1725	TJ-AT-1725	TJ-PG-1725	TJ-PT-1725	TJ-1725P	TJ-1725	155	230
175 x 250 x 100	TJ-AG-1725-1	TJ-AT-1725-1	TJ-PG-1725-1	TJ-PT-1725-1	TJ-1725P	TJ-1725	155	230
180 x 250 x 100	TJ-AG-1825	TJ-AT-1825	TJ-PG-1825	TJ-PT-1825	—	TJ-1825	160	230
200 x 200 x 95	TJ-AG-2020-S	TJ-AT-2020-S	TJ-PG-2020-S	TJ-PT-2020-S	TJ-2020P	TJ-2020	185	185
200 x 200 x 130	TJ-AG-2020	TJ-AT-2020	TJ-PG-2020	TJ-PT-2020	TJ-2020P	TJ-2020	185	185
200 x 250 x 100	TJ-AG-2025	TJ-AT-2025	TJ-PG-2025	TJ-PT-2025	—	TJ-2025	180	228

适用附件 Accessories

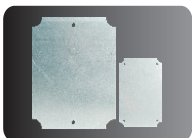

Steel mounting plate
金属底板 (镀锌)

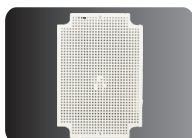

Plastic mounting plate
塑料底板(ABS)



Wall brackets for Plastic box
塑料盒不锈钢挂墙钩
MODEL:WP-01



Plastic enclosure screw
塑料螺丝
MODEL:TJLT-70



Plastic enclosure screw
塑料螺丝
MODEL:TJM-60



Plastic enclosure screw
塑料螺丝
MODEL:TJS-50

TJ系列 塑料盒(铰链型)

TJ Series Plastic Enclosure(Hinge type)



Dimension(允许误差 ± 1mm)

BASE

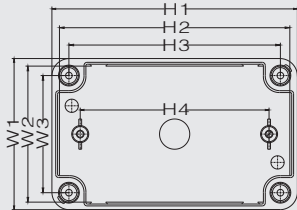

COVER
BASE

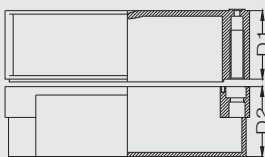

COVER
+BASE

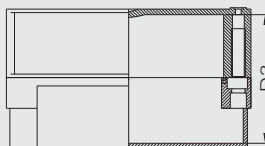

MOUNTING
PLATE

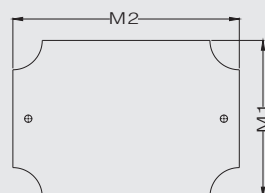

Size	Division	W1	W2	W3	H1	H2	H3	H4	D1	D2	D3
75 × 125 × 75		75	66	56	125	116	107	90	25	50	60
75 × 125 × 100		75	66	46	125	116	107	90	50	50	85
80 × 110 × 70		80	72	62	110	102	92	80	20	50	52
80 × 110 × 85		80	72	62	110	102	92	80	35	50	68
80 × 130 × 70		80	72	62	130	122	112	100	20	50	52
80 × 130 × 85		80	72	62	130	122	112	100	35	50	68
80 × 160 × 90		80	76	66	160	156	146	138	15	75	72
80 × 180 × 70		80	72	62	180	172	162	150	20	50	52
80 × 180 × 85		80	72	62	180	172	162	150	35	50	68
80 × 250 × 70		80	72	62	250	242	232	220	20	50	52
80 × 250 × 85		80	72	62	250	242	232	220	35	50	60
100 × 100 × 75		100	89	82	100	89	82	60	20	55	60
100 × 180 × 75		100	91	76	180	151	155	142	15	60	60
100 × 223 × 75		100	91	76	223	194	198	187	15	60	60
125 × 125 × 75		125	117	105	125	117	105	70	20	55	58
125 × 125 × 100		125	117	105	125	117	105	70	20	80	82
125 × 175 × 75		125	117	105	175	167	156	140	25	50	58
125 × 175 × 100		125	117	105	175	167	156	140	50	50	82
120 × 200 × 75		120	108	103	200	190	182	160	20	55	65
140 × 170 × 95		140	132	122	170	162	152	130	20	75	76
140 × 230 × 95		140	132	122	230	222	212	190	20	75	76
150 × 200 × 75		150	140	132	200	192	182	160	20	55	58
150 × 200 × 100		150	140	132	200	192	182	160	20	80	82
150 × 200 × 130		150	140	132	200	192	182	160	50	80	112
150 × 250 × 100		150	142	132	250	242	232	210	20	80	82
150 × 250 × 130		150	142	132	250	242	232	210	50	80	112
175 × 175 × 75		175	167	156	175	167	156	140	25	50	60
175 × 175 × 100		175	167	156	175	167	156	140	50	50	85
175 × 250 × 75		175	166	156	250	242	232	214	25	50	60
175 × 250 × 100		175	166	156	250	242	232	214	50	50	85
180 × 250 × 100		180	170	155	250	239	225	216	15	85	86
200 × 200 × 95		200	192	182	200	192	182	120	20	75	77
200 × 200 × 130		200	192	182	200	192	182	120	50	80	112
200 × 250 × 100		200	190	178	250	240	228	215	25	75	82

防水防尘等级 IP 66
温度范围 -40℃+80℃

备注
前面带★表示螺丝是不锈钢材质

TJ Series Plastic Enclosure(Hinge type)

产品特征 Product characteristics



CE IP66



有极好的绝缘性能, 抗化学腐蚀和抗机械挤压的性能。达到高要求的IP66防护等级, 所有的箱体都防尘、防水、抗80° 高温。采用ABS、PC等材料制成, 外形美观、性能坚固。产品适用于小型终端机、按钮盒、信号机、继电器、计量器、通信用接线盒等设备。

The enclosure is according to EN60529 standard, free from corrosion, compressive property and insulation, widely used in electronics, communications, fire fighting apparatus, control panel terminal boxes, public accommodation, ship industry, food industry etc. we always give top priority to quality and safety, your satisfaction is guaranteed.

型号规格 Model and size

Size W H D	产品型号 Product model (Stainless steel latch+Screw type)				内板型号 Plate Model		金属内板规格 Plate Size	
	ABS	PC/ABS	PC	PC	Plastic(塑料)	Metal(金属)	M1	M2
	盖:灰色ABS 盒体:灰色ABS Cover:Grey ABS Body:Grey ABS	盖:透明PC 盒体:灰色ABS Cover:Transparent PC Body:Grey ABS	盖:灰色PC 盒体:灰色PC Cover:Grey PC Body:Grey PC	盖:透明PC 盒体:灰色PC Cover:Transparent PC Body:Grey PC				
75 x 125 x 75	TJ-AGH-0712	TJ-ATH-0712	TJ-PGH-0712	TJ-PTH-0712	TJ-0712P	TJ-0712	60	110
75 x 125 x 100	TJ-AGH-0712-1	TJ-ATH-0712-1	TJ-PGH-0712-1	TJ-PTH-0712-1	TJ-0712P	TJ-0712	60	110
80 x 80 x 60	TJ-AGH-0808	TJ-ATH-0808	TJ-PGH-0808	TJ-PTH-0808	—	TJ-0808	65	65
80 x 110 x 70	TJ-AGH-0811	TJ-ATH-0811	TJ-PGH-0811	TJ-PTH-0811	TJ-0811P	TJ-0811	67	91
80 x 110 x 85	TJ-AGH-0811-1	TJ-ATH-0811-1	TJ-PGH-0811-1	TJ-PTH-0811-1	TJ-0811P	TJ-0811	67	91
80 x 130 x 70	TJ-AGH-0813	TJ-ATH-0813	TJ-PGH-0813	TJ-PTH-0813	TJ-0813P	TJ-0813	67	117
80 x 130 x 85	TJ-AGH-0813-1	TJ-ATH-0813-1	TJ-PGH-0813-1	TJ-PTH-0813-1	TJ-0813P	TJ-0813	67	117
80 x 160 x 90	TJ-AGH-0816	TJ-ATH-0816	TJ-PGH-0816	TJ-PTH-0816	TJ-0816P	TJ-0816	67	151
80 x 180 x 70	TJ-AGH-0818	TJ-ATH-0818	TJ-PGH-0818	TJ-PTH-0818	TJ-0818P	TJ-0818	70	170
80 x 180 x 85	TJ-AGH-0818-1	TJ-ATH-0818-1	TJ-PGH-0818-1	TJ-PTH-0818-1	TJ-0818P	TJ-0818	70	170
80 x 250 x 70	TJ-AGH-0825	TJ-ATH-0825	TJ-PGH-0825	TJ-PTH-0825	TJ-0825P	TJ-0825	67	237
80 x 250 x 85	TJ-AGH-0825-1	TJ-ATH-0825-1	TJ-PGH-0825-1	TJ-PTH-0825-1	TJ-0825P	TJ-0825	67	237
100 x 100 x 75	TJ-AGH-1010	TJ-ATH-1010	TJ-PGH-1010	TJ-PTH-1010	—	TJ-1010	80	80
100 x 180 x 75	TJ-AGH-1018	TJ-ATH-1018	TJ-PGH-1018	TJ-PTH-1018	—	TJ-1018	82	162
100 x 223 x 75	TJ-AGH-1022	TJ-ATH-1022	TJ-PGH-1022	TJ-PTH-1022	—	TJ-1022	80	205
125 x 125 x 75	TJ-AGH-1212-S	TJ-ATH-1212-S	TJ-PGH-1212-S	TJ-PTH-1212-S	TJ-1212P	TJ-1212	112	112
125 x 125 x 100	TJ-AGH-1212	TJ-ATH-1212	TJ-PGH-1212	TJ-PTH-1212	TJ-1212P	TJ-1212	112	112
125 x 175 x 75	TJ-AGH-1217	TJ-ATH-1217	TJ-PGH-1217	TJ-PTH-1217	TJ-1217P	TJ-1217	112	162
125 x 175 x 100	TJ-AGH-1217-1	TJ-ATH-1217-1	TJ-PGH-1217-1	TJ-PTH-1217-1	TJ-1217P	TJ-1217	112	162
120 x 200 x 75	TJ-AGH-1220	TJ-ATH-1220	TJ-PGH-1220	TJ-PTH-1220	—	TJ-1220	95	175
140 x 170 x 95	TJ-AGH-1417	TJ-ATH-1417	TJ-PGH-1417	TJ-PTH-1417	TJ-1417P	TJ-1417	127	154
140 x 230 x 95	TJ-AGH-1423	TJ-ATH-1423	TJ-PGH-1423	TJ-PTH-1423	TJ-1423P	TJ-1423	125	215
150 x 200 x 75	TJ-AGH-1520-S	TJ-ATH-1520-S	TJ-PGH-1520-S	TJ-PTH-1520-S	TJ-1520P	TJ-1520	136	185
150 x 200 x 100	TJ-AGH-1520	TJ-ATH-1520	TJ-PGH-1520	TJ-PTH-1520	TJ-1520P	TJ-1520	136	185
150 x 200 x 130	TJ-AGH-1520-1	TJ-ATH-1520-1	TJ-PGH-1520-1	TJ-PTH-1520-1	TJ-1520P	TJ-1520	136	185
150 x 250 x 100	TJ-AGH-1525	TJ-ATH-1525	TJ-PGH-1525	TJ-PTH-1525	TJ-1525P	TJ-1525	135	235
150 x 250 x 130	TJ-AGH-1525-1	TJ-ATH-1525-1	TJ-PGH-1525-1	TJ-PTH-1525-1	TJ-1525P	TJ-1525	135	235
175 x 175 x 75	TJ-AGH-1717	TJ-ATH-1717	TJ-PGH-1717	TJ-PTH-1717	TJ-1717P	TJ-1717	159	159
175 x 175 x 100	TJ-AGH-1717-1	TJ-ATH-1717-1	TJ-PGH-1717-1	TJ-PTH-1717-1	TJ-1717P	TJ-1717	159	159
175 x 250 x 75	TJ-AGH-1725	TJ-ATH-1725	TJ-PGH-1725	TJ-PT-1725	TJ-1725P	TJ-1725	155	230
175 x 250 x 100	TJ-AGH-1725-1	TJ-ATH-1725-1	TJ-PGH-1725-1	TJ-PTH-1725-1	TJ-1725P	TJ-1725	155	230
180 x 250 x 100	TJ-AGH-1825	TJ-ATH-1825	TJ-PGH-1825	TJ-PTH-1825	—	TJ-1825	160	230
200 x 200 x 95	TJ-AGH-2020-S	TJ-ATH-2020-S	TJ-PGH-2020-S	TJ-PTH-2020-S	TJ-2020P	TJ-2020	185	185
200 x 200 x 130	TJ-AGH-2020	TJ-ATH-2020	TJ-PGH-2020	TJ-PTH-2020	TJ-2020P	TJ-2020	185	185
200 x 250 x 100	TJ-AGH-2025	TJ-ATH-2025	TJ-PGH-2025	TJ-PTH-2025	—	TJ-2025	180	228

适用附件 Accessories

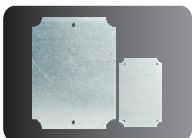

Steel mounting plate
金属底板 (镀锌)

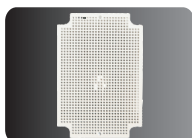

Plastic mounting plate
塑料底板(ABS)



Wall brackets for Plastic box
塑料盒不锈钢挂墙钩
MODEL:WP-01



Cap for Screw
堵塞头
MODEL:ZC-S10



Stainless steel hinge
不锈钢铰链
MODEL:HG-01



Stainless steel latch
不锈钢搭扣
MODEL:LC-01

TJ Series Plastic Enclosure(Screw type)

产品特征 Product characteristics



CE IP66



采用高强度ABS、PC耐火材料和UV添加材料制成，外形美观大方，具有很高的可塑性和坚固性。适用于端子箱、配电板、仪器盒、电力设备用BOX以及控制箱作用方便。

With high strength ABS, PC refractories and UV added material, the enclosure has beautiful appearance, high plasticity and ruggedness. It is Suitable for terminal boxes, distribution panels, instrument boxes, electrical equipment boxes and control boxes, simple and easy to use.

型号规格 Model and size

Size W H D	产品型号 Product model (Screw type)				内板型号 Plate Model		金属内板规格 Plate Size	
	ABS 盖:灰色ABS 盒体:灰色ABS Cover:Grey ABS Body:Grey ABS	PC/ABS 盖:透明PC 盒体:灰色ABS Cover:Transparent PC Body:Grey ABS	PC 盖:灰色PC 盒体:灰色PC Cover:Grey PC Body:Grey PC	PC 盖:透明PC 盒体:灰色PC Cover:Transparent PC Body:Grey PC	Plastic(塑料)	Metal(金属)	M1	M2
280 x 190 x 130	TJ-AG-2819	TJ-AT-2819	TJ-PG-2819	TJ-PT-2819	TJ-2819P	TJ-2819	160	260
280 x 190 x 180	TJ-AG-2819-1	TJ-AT-2819-1	TJ-PG-2819-1	TJ-PT-2819-1	TJ-2819P	TJ-2819	160	260
280 x 190 x 180	TJ-AG-2819-2	TJ-AT-2819-2	TJ-PG-2819-2	TJ-PT-2819-2	TJ-2819P	TJ-2819	160	260
280 x 190 x 230	TJ-AG-2819-3	TJ-AT-2819-3	TJ-PG-2819-3	TJ-PT-2819-3	TJ-2819P	TJ-2819	160	260
280 x 280 x 130	TJ-AG-2828	TJ-AT-2828	TJ-PG-2828	TJ-PT-2828	TJ-2828P	TJ-2828	245	245
280 x 280 x 180	TJ-AG-2828-1	TJ-AT-2828-1	TJ-PG-2828-1	TJ-PT-2828-1	TJ-2828P	TJ-2828	245	245
280 x 280 x 180	TJ-AG-2828-2	TJ-AT-2828-2	TJ-PG-2828-2	TJ-PT-2828-2	TJ-2828P	TJ-2828	245	245
280 x 280 x 230	TJ-AG-2828-3	TJ-AT-2828-3	TJ-PG-2828-3	TJ-PT-2828-3	TJ-2828P	TJ-2828	245	245
340 x 280 x 130	TJ-AG-3428	TJ-AT-3428	TJ-PG-3428	TJ-PT-3428	TJ-3428P	TJ-3428	245	305
280 x 380 x 180	TJ-AG-3428-1	TJ-AT-3428-1	TJ-PG-3428-1	TJ-PT-3428-1	TJ-3428P	TJ-3428	245	305
380 x 190 x 100	TJ-AG-3819-S	TJ-AT-3819-S	TJ-PG-3819-S	TJ-PT-3819-S	—	TJ-3819	160	340
380 x 190 x 130	TJ-AG-3819	TJ-AT-3819	TJ-PG-3819	TJ-PT-3819	—	TJ-3819	160	340
380 x 190 x 180	TJ-AG-3819-1	TJ-AT-3819-1	TJ-PG-3819-1	TJ-PT-3819-1	—	TJ-3819	160	340
280 x 380 x 130	TJ-AG-3828	TJ-AT-3828	TJ-PG-3828	TJ-PT-3828	TJ-3828P	TJ-3828	245	345
280 x 380 x 180	TJ-AG-3828-1	TJ-AT-3828-1	TJ-PG-3828-1	TJ-PT-3828-1	TJ-3828P	TJ-3828	245	345
280 x 380 x 180	TJ-AG-3828-2	TJ-AT-3828-2	TJ-PG-3828-2	TJ-PT-3828-2	TJ-3828P	TJ-3828	245	345
280 x 380 x 230	TJ-AG-3828-3	TJ-AT-3828-3	TJ-PG-3828-3	TJ-PT-3828-3	TJ-3828P	TJ-3828	245	345
280 x 560 x 130	TJ-AG-2856	TJ-AT-2856	TJ-PG-2856	TJ-PT-2856	TJ-2828P x 2	TJ-2856	245	525
380 x 560 x 180	TJ-AG-3856	TJ-AT-3856	TJ-PG-3856	TJ-PT-3856	TJ-3828P x 2	TJ-3856	345	525

适用附件 Accessories

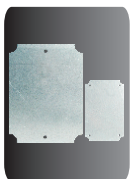

Steel mounting plate
金属底板 (镀锌)



Plastic mounting plate
塑料底板(ABS)



Wall brackets for Plastic box
塑料盒不锈钢挂墙钩
MOEDL:WP-02



Door hinge fixing piece
里门铰链固定件
MOEDL:LC-S11

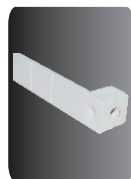

Fixing bolts
里门固定架
MOEDL:LC-S12



Plastic enclosure screw
塑料螺丝
MOEDL:TJCB-70



Plastic enclosure screw
塑料螺丝
MOEDL:TJHB-70



Plastic enclosure screw
塑料螺丝
MOEDL:TJCB-50



Plastic enclosure screw
塑料螺丝
MODEL:TJHB-50

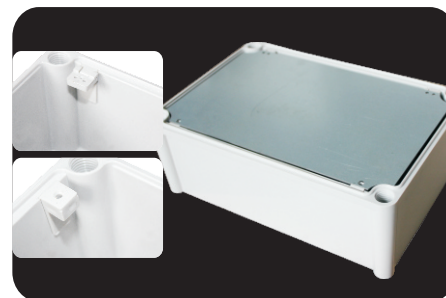

TJ Series Plastic Enclosure(Hinge type)

产品特征 Product characteristics



采用高强度ABS、PC耐火材料和UV添加材料制成，外形美观大方，具有很高的可塑性和坚固性。适用于端子箱、配电板、仪器盒、电力设备用BOX以及控制箱作用方便。

With high strength ABS, PC refractories and UV added material, the enclosure has beautiful appearance, high plasticity and ruggedness. It is Suitable for terminal boxes, distribution panels, instrument boxes, electrical equipment boxes and control boxes, simple and easy to use.

型号规格 Model and size

Size W H D	产品型号 Product model (Screw type)				内板型号 Plate Model		金属内板规格 Plate Size	
	ABS 盖:灰色ABS 盒体:灰色ABS Cover:Grey ABS Body:Grey ABS	PC/ABS 盖:透明PC 盒体:灰色ABS Cover:Transparent PC Body:Grey ABS	PC 盖:灰色PC 盒体:灰色PC Cover:Grey PC Body:Grey PC	PC 盖:透明PC 盒体:灰色PC Cover:Transparent PC Body:Grey PC	Plastic(塑料)	Metal(金属)	M1	M2
280 x 190 x 130	TJ-AGH-2819	TJ-ATH-2819	TJ-PGH-2819	TJ-PTH-2819	TJ-2819P	TJ-2819	160	260
280 x 190 x 180	TJ-AGH-2819-1	TJ-ATH-2819-1	TJ-PGH-2819-1	TJ-PTH-2819-1	TJ-2819P	TJ-2819	160	260
280 x 190 x 180	TJ-AGH-2819-2	TJ-ATH-2819-2	TJ-PGH-2819-2	TJ-PTH-2819-2	TJ-2819P	TJ-2819	160	260
280 x 190 x 230	TJ-AGH-2819-3	TJ-ATH-2819-3	TJ-PGH-2819-3	TJ-PTH-2819-3	TJ-2819P	TJ-2819	160	260
280 x 280 x 130	TJ-AGH-2828	TJ-ATH-2828	TJ-PGH-2828	TJ-PTH-2828	TJ-2828P	TJ-2828	245	245
280 x 280 x 180	TJ-AGH-2828-1	TJ-ATH-2828-1	TJ-PGH-2828-1	TJ-PTH-2828-1	TJ-2828P	TJ-2828	245	245
280 x 280 x 180	TJ-AGH-2828-2	TJ-ATH-2828-2	TJ-PGH-2828-2	TJ-PTH-2828-2	TJ-2828P	TJ-2828	245	245
280 x 280 x 230	TJ-AGH-2828-3	TJ-ATH-2828-3	TJ-PGH-2828-3	TJ-PTH-2828-3	TJ-2828P	TJ-2828	245	245
340 x 280 x 130	TJ-AGH-3428	TJ-ATH-3428	TJ-PGH-3428	TJ-PTH-3428	TJ-3428P	TJ-3428	245	305
280 x 380 x 180	TJ-AGH-3428-1	TJ-ATH-3428-1	TJ-PGH-3428-1	TJ-PTH-3428-1	TJ-3428P	TJ-3428	245	305
380 x 190 x 100	TJ-AGH-3819-S	TJ-ATH-3819-S	TJ-PGH-3819-S	TJ-PTH-3819-S	—	TJ-3819	160	340
380 x 190 x 130	TJ-AGH-3819	TJ-ATH-3819	TJ-PGH-3819	TJ-PTH-3819	—	TJ-3819	160	340
380 x 190 x 180	TJ-AGH-3819-1	TJ-ATH-3819-1	TJ-PGH-3819-1	TJ-PTH-3819-1	—	TJ-3819	160	340
280 x 380 x 130	TJ-AGH-3828	TJ-ATH-3828	TJ-PGH-3828	TJ-PTH-3828	TJ-3828P	TJ-3828	245	345
280 x 380 x 180	TJ-AGH-3828-1	TJ-ATH-3828-1	TJ-PGH-3828-1	TJ-PTH-3828-1	TJ-3828P	TJ-3828	245	345
280 x 380 x 180	TJ-AGH-3828-2	TJ-ATH-3828-2	TJ-PGH-3828-2	TJ-PTH-3828-2	TJ-3828P	TJ-3828	245	345
280 x 380 x 230	TJ-AGH-3828-3	TJ-ATH-3828-3	TJ-PGH-3828-3	TJ-PTH-3828-3	TJ-3828P	TJ-3828	245	345
280 x 560 x 130	TJ-AGH-2856	TJ-ATH-2856	TJ-PGH-2856	TJ-PTH-2856	TJ-2828P x 2	TJ-2856	245	525
380 x 560 x 180	TJ-AGH-3856	TJ-ATH-3856	TJ-PGH-3856	TJ-PTH-3856	TJ-3828P x 2	TJ-3856	345	525

适用附件 Accessories

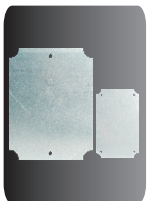

Steel mounting plate
金属底板 (镀锌)



Plastic mounting plate
塑料底板 (ABS)



Wall brackets for Plastic box
塑料盒不锈钢挂墙钩
MOEDL:WP-02



Door hinge fixing piece
里门铰链固定件
MOEDL:LC-S11



Fixing bolts
里门固定架
MOEDL:LC-S12



Cap for Screw
堵塞头
MODEL:ZC-S10

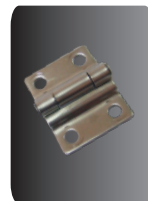

Stainless steel hinge
不锈钢铰链
MODEL:HG-02



Stainless steel latch
不锈钢搭扣
MODEL:LC-02



TE系列 塑料盒(塑料搭扣+铰链型)

TE Series Plastic Enclosure(Plastic latch + hinge type)

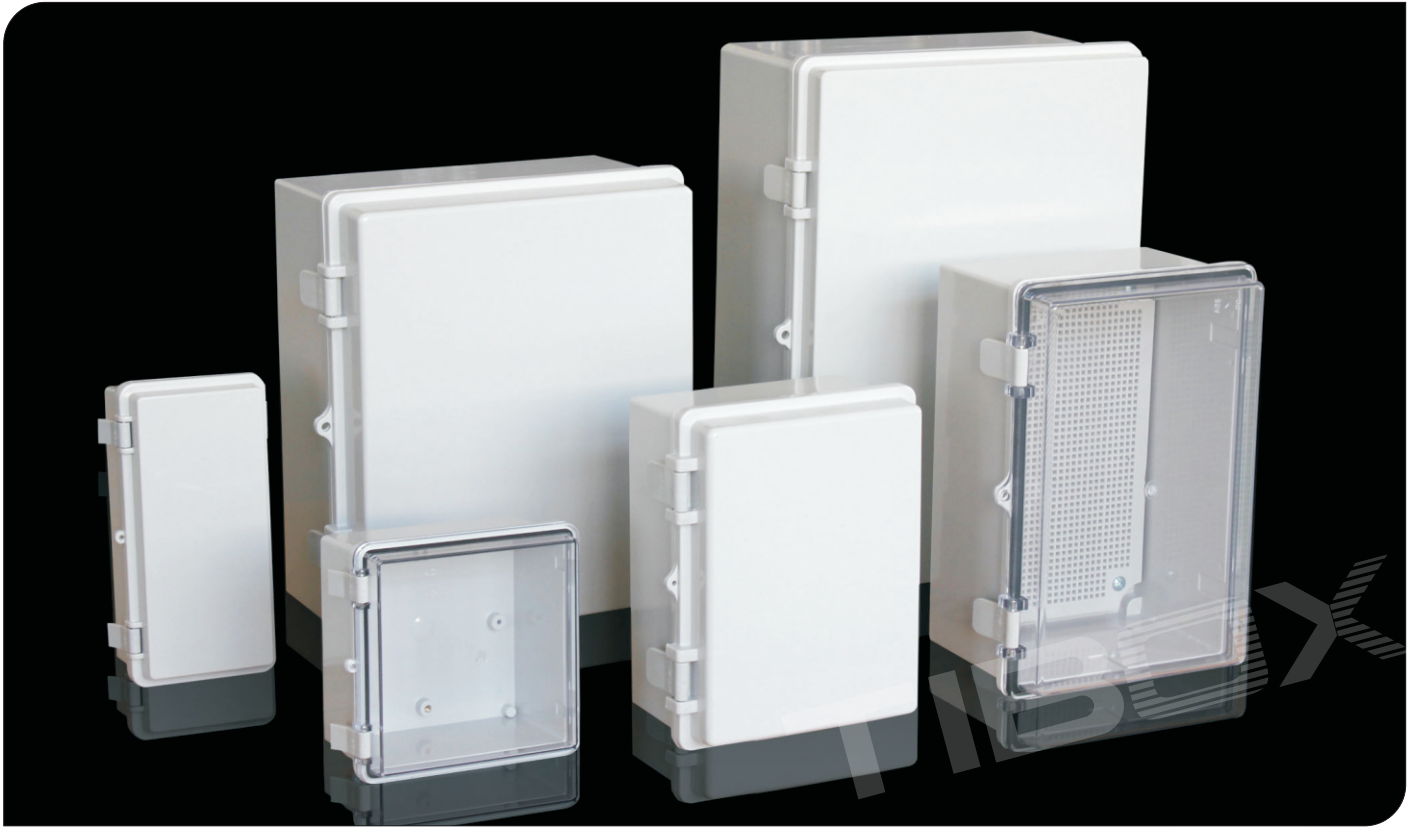

Dimension(允许误差 ± 1mm)

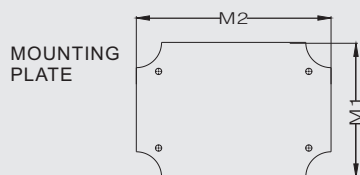
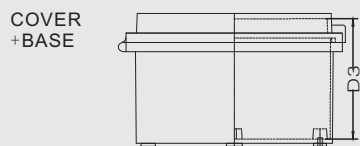
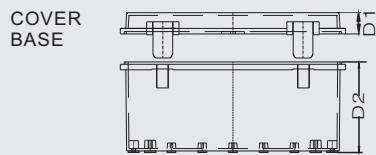
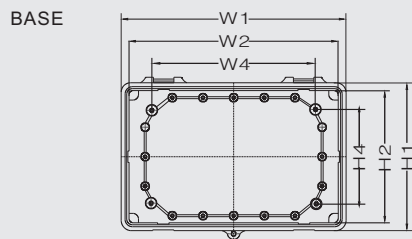

Size	Division	W ₁	W ₂	W ₄	H ₁	H ₂	H ₄	D ₁	D ₂	D ₃
100 × 150 × 70		100	80	—	150	130	100	20	50	52
100 × 200 × 70		100	78	—	200	180	150	20	50	52
150 × 150 × 90		150	130	100	150	130	100	20	70	70
170 × 220 × 110		170	152	—	220	202	162	30	80	90
190 × 290 × 140		190	162	126	290	265	210	30	110	120
250 × 300 × 150		250	242	230	300	292	282	40	110	130
250 × 350 × 180		250	232	175	350	335	275	40	140	160
290 × 190 × 140		290	265	210	190	162	126	30	110	120
290 × 390 × 160		290	264	215	390	374	315	28	132	144
300 × 300 × 130		330	308	280	330	308	280	30	100	110
350 × 465 × 160		372	350	295	482	460	410	30	130	140

防水防尘等级 IP 66
温度范围 -40°C~+80°C

TE Series Plastic Enclosure(Plastic latch + hinge type)

产品特征 Product characteristics



在热销的塑料盒产品中，NICE BOX的功能和作业性能最为优越，价格却与Steel Box 相似，从而提高了产品的竞争力。产品中包含防EML辐射、防静电的物质，以力求保护内藏品、防护电气和电气仪表。
适用于小型端子箱、信号机、终端机、以及照明用PUSH Box品种及大小齐全，便于使用。

Out of the plastic boxes which are selling at present,It's ability and working efficiency,the competitive power is much higher with the low price same as the level of steel Box.The products were added the electromagnetic interference(EMI) and preventing substance of the static electricity,and the strong point was given to the relevant mechanical protection of electricity,electron and etc.
The Uses are possible according to the size such as small Terminal Box,Signal,Terminal and Push button,Control Box etc.

型号规格 Model and size

Size W H D	产品型号 Product model (Screw type)				内板型号 Plate Model		金属内板规格 Plate Size	
	ABS 盖:灰色ABS 箱体:灰色ABS Cover:Grey ABS Body:Grey ABS	PC/ABS 盖:透明PC 箱体:灰色ABS Cover:Transparent PC Body:Grey ABS	PC 盖:灰色PC 箱体:灰色PC Cover:Grey PC Body:Grey PC	PC 盖:透明PC 箱体:灰色PC Cover:Transparent PC Body:Grey PC	Plastic(塑料)	Metal(金属)	M1	M2
100 × 150 × 70	TE-AG-1015	TE-AT-1015	TE-PG-1015	TE-PT-1015	TJ-1015P	TJ-1015	77	127
100 × 200 × 70	TE-AG-1020	TE-AT-1020	TE-PG-1020	TE-PT-1020	TJ-1020P	TJ-1020	70	170
150 × 150 × 90	TE-AG-1515	TE-AT-1515	TE-PG-1515	TE-PT-1515	—	TJ-1515	120	120
170 × 220 × 110	TE-AG-1722	TE-AT-1722	TE-PG-1722	TE-PT-1722	TJ-1722P	TJ-1722	148	190
190 × 290 × 140	TE-AG-1929	TE-AT-1929	TE-PG-1929	TE-PT-1929	TJ-1929P	TJ-1929	160	260
250 × 300 × 150	TE-AG-2530	TE-AT-2530	TE-PG-2530	TE-PT-2530	—	TJ-2530	226	275
250 × 350 × 180	TE-AG-2535	TE-AT-2535	TE-PG-2535	TE-PT-2535	—	TJ-2535	215	315
290 × 190 × 140	TE-AG-2919	TE-AT-2919	TE-PG-2919	TE-PT-2919	TJ-2919P	TJ-2919	260	160
290 × 390 × 160	TE-AG-2939	TE-AT-2939	TE-PG-2939	TE-PT-2939	TJ-2939P	TJ-2939	245	345
300 × 300 × 130	TE-AG-3030	TE-AT-3030	TE-PG-3030	TE-PT-3030	TJ-3030P	TJ-3030	300	300
350 × 465 × 160	TE-AG-3546	TE-AT-3546	TE-PG-3546	TE-PT-3546	—	TJ-3546	325	425

适用附件 Accessories

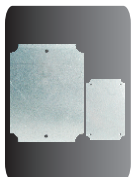

Steel mounting plate
金属底板 (镀锌)

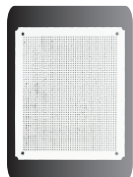

Plastic mounting plate
塑料底板 (ABS)



Wall brackets for Plastic box
塑料盒不锈钢挂墙钩
MOEDL:WP-02



Door hinge fixing piece
里门铰链固定件
MOEDL:LC-S11

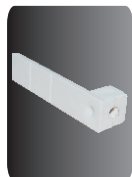

Fixing bolts
里门固定架
MOEDL:LC-S12

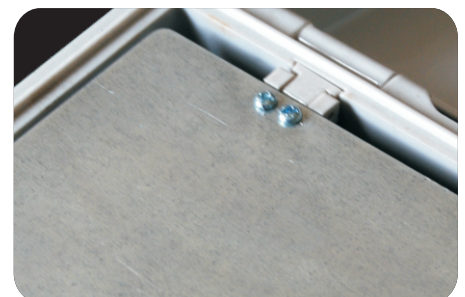

TE系列 塑料盒(金属搭扣+铰链型)

TE Series Plastic Enclosure(Metal latch + Hinge type)



Dimension(允许误差 ± 1mm)

防水防尘等级	IP 66
温度范围	-40℃~+80℃

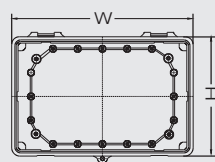

BASE

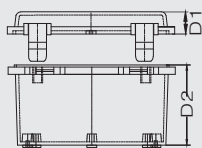

COVER
BASE

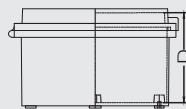

COVER
+BASE

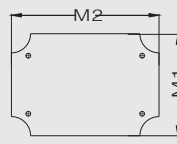

MOUNTING
PLATE

Out of the plastic boxes which are selling at present, it's ability and working efficiency, the competitive power is much higher with the low price same as the level of steel box. The products were added the electromagnetic interference(EMI) and prevent substance of the static electricity, and the strong point was given to the relevant mechanical protection of electricity, electron and etc.

Temperature range:-40 to +120℃
SMC:Fiber glass(body)
PC:Poly Carbamate(cover)

Size	产品型号 Product Model					ABS		PC/ABS		内板型号 Plate Model		金属内板规格 Plate Size	
	W	H	D	D ₁	D ₂	盖:灰色ABS Cover:Grey ABS Body:Glass fiber	盒体:灰色ABS Body:Grey ABS	盖:透明PC Cover:Transparent PC Body:Grey ABS	盒体:灰色ABS Body:Grey ABS	Plastic(塑料)	Metal(金属)	M1	M2
530 x 630 x 185	530	630	185	35	150	TE-AG-5363-S	TE-AT-5363-S	TE-AT-5363-S	TE-AT-5363-S	—	TJ-5363	460	560
530 x 630 x 255	530	630	255	35	220	TE-AG-5363	TE-AT-5363	TE-AT-5363	TE-AT-5363	—	TJ-5363	460	560
530 x 730 x 185	530	730	185	35	150	TE-AG-5373-S	TE-AT-5373-S	TE-AT-5373-S	TE-AT-5373-S	—	TJ-5373	460	660
530 x 730 x 255	530	730	255	35	220	TE-AG-5373	TE-AT-5373	TE-AT-5373	TE-AT-5373	—	TJ-5373	460	660
630 x 830 x 185	630	830	185	35	150	TE-AG-6383-S	TE-AT-6383-S	TE-AT-6383-S	TE-AT-6383-S	—	TJ-6383	560	760
630 x 830 x 285	630	830	255	35	220	TE-AG-6383	TE-AT-6383	TE-AT-6383	TE-AT-6383	—	TJ-6383	560	760



TJ Series Plastic Enclosure(Screw type)



Dimension(允许误差 ± 1mm)

防水防尘等级	IP 66
温度范围	-40℃~+80℃

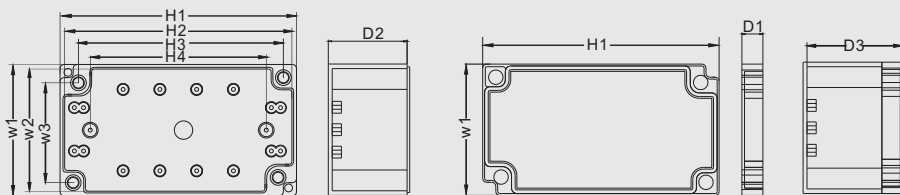

The enclosure is according to EN60529 standard, free from corrosion, compressive property and insulation, widely used in electronics, communications, fire fighting apparatus, control panel terminal boxes, public accommodation, ship industry, food industry etc. we always give top priority to quality and safety, your satisfaction is guaranteed.

Size	Division	W ₁	W ₂	W ₃	H ₁	H ₂	H ₃	H ₄	D ₁	D ₂	D ₃
55 × 70 × 43		55	47	47	70	62	52	41	8	35	43
55 × 91 × 43		55	47	47	91	89	78	61	8	35	43
75 × 91 × 43		75	67	67	91	89	78	61	8	35	43
91 × 110 × 43		91	89	78	110	108	102	90	8	35	43
100 × 180 × 75		100	91	76	180	151	155	142	15	60	60
100 × 223 × 75		100	91	76	223	194	198	187	15	60	60

型号规格 Model and size

Size W H D	产品型号 Product model (Screw type)				内板型号 Plate Model		金属内板规格 Plate Size	
	ABS 盖:灰色ABS 盒体:灰色ABS Cover:Grey ABS Body:Grey ABS	PC/ABS 盖:透明PC 盒体:灰色ABS Cover:Transparent PC Body:Grey ABS	PC 盖:灰色PC 盒体:灰色PC Cover:Grey PC Body:Grey PC	PC 盖:透明PC 盒体:灰色PC Cover:Transparent PC Body:Grey PC	Plastic(塑料)	Metal(金属)	M1	M2
55 × 70 × 43	TJ-AG-0507	TJ-AT-0507	TJ-PG-0507	TJ-PT-0507	—	TJ-0507	45	60
55 × 91 × 43	TJ-AG-0509	TJ-AT-0509	TJ-PG-0509	TJ-PT-0509	—	TJ-0509	45	80
75 × 91 × 43	TJ-AG-0709	TJ-AT-0709	TJ-PG-0709	TJ-PT-0709	—	TJ-0709	65	80
91 × 110 × 43	TJ-AG-0910	TJ-AT-0910	TJ-PG-0910	TJ-PT-0910	—	TJ-0910	80	100
100 × 180 × 75	TJ-AG-1018	TJ-AT-1018	TJ-PG-1018	TJ-PT-1018	—	TJ-1018	82	162
100 × 223 × 75	TJ-AG-1022	TJ-AT-1022	TJ-PG-1022	TJ-PT-1022	—	TJ-1022	80	205

T□系列 塑料盒

T□ Series Plastic Enclosure



采用高强度ABS、PC耐火材料和UV添加材料制成，外形美观大方，具有很高的可塑性和坚固性。适用于端子箱、配电板、仪器盒、电力设备用BOX以及控制箱作用方便。

With high strength ABS, PC refractories and UV added material, the enclosure has beautiful appearance, high plasticity and ruggedness. It is Suitable for terminal boxes, distribution panels, instrument boxes, electrical equipment boxes and control boxes, simple and easy to use.

Dimension(允许误差 ± 1mm)

防水防尘等级 IP 66
温度范围 -40℃+80℃

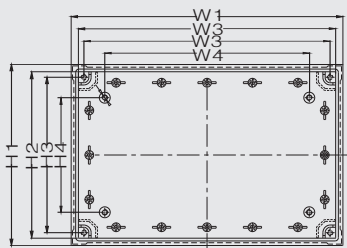

BASE



COVER BASE

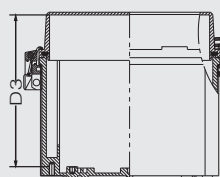

COVER +BASE

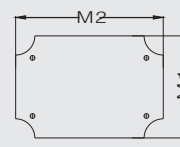

MOUNTING PLATE

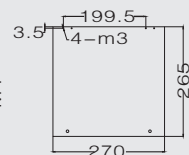

Inner door(3030)

Size	Division	W1	W2	W3	W4	H1	H2	H3	H4	D1	D2	D3
200×300×150		300	278	268	225	200	170	168	125	30	120	135
200×300×180		300	281	270	227	200	181	170	127	50	130	165
300×300×180		300	281	270	227	300	281	270	227	50	130	165
300×400×180		400	381	370	327	300	281	270	227	50	130	165
400×500×200		500	482	470	428	400	382	370	328	50	150	165
400×600×220		600	582	570	525	400	382	370	328	50	170	205

T□ Series Plastic Enclosure

MG塑料盒



KG塑料盒



TG塑料盒



T□系列 中门配件

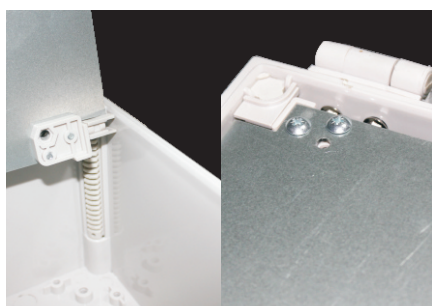

T□系列 立柱固定件

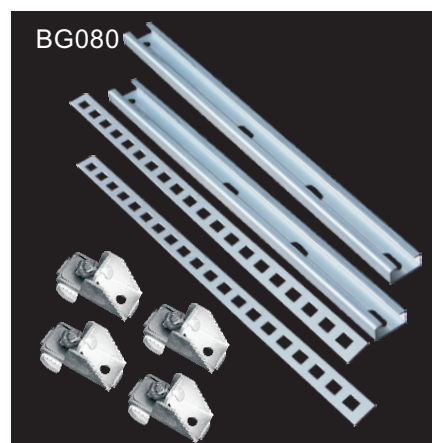
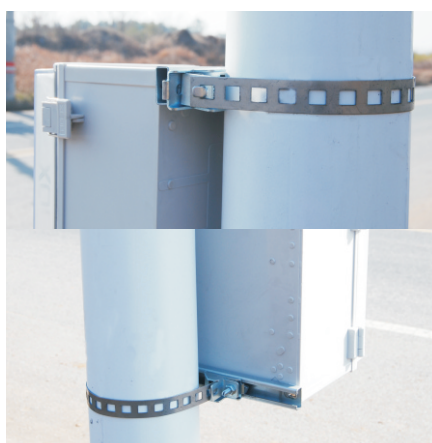

MG系列 塑料盒(塑料扣+铰链型)

MG Series Plastic Enclosure(Plastic latch+hinge type)

MG系列 塑料盒

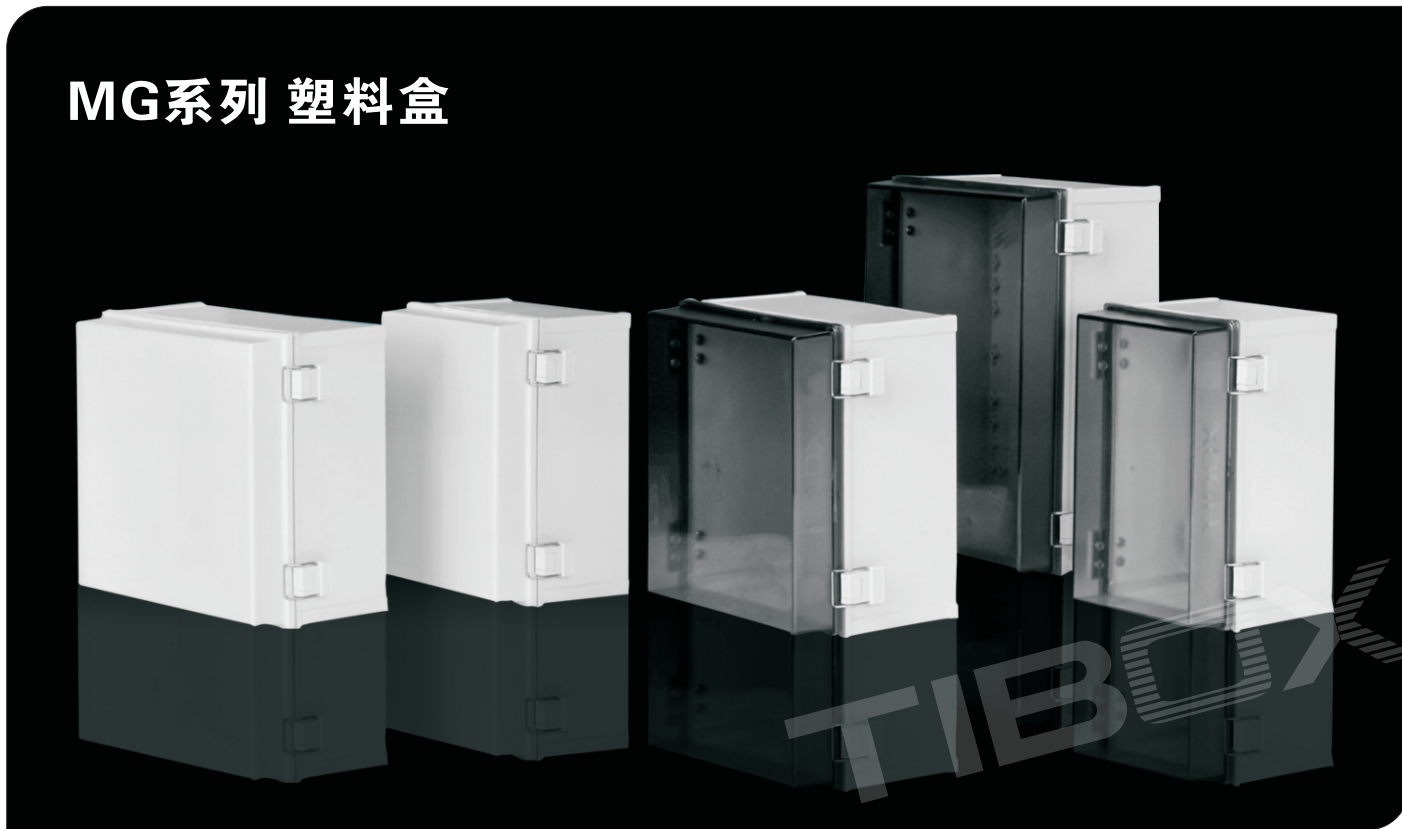

产品特征 Product characteristics



CE IP66



采用高强度ABS、PC耐火材料和UV添加材料制成，外形美观大方，具有很高的可塑性和坚固性。适用于端子箱、配电板、仪器盒、电力设备用BOX以及控制箱作用方便。

With high strength ABS, PC refractories and UV added material, the enclosure has beautiful appearance, high plasticity and ruggedness. It is Suitable for terminal boxes, distribution panels, instrument boxes, electrical equipment boxes and control boxes, simple and easy to use.

型号规格 Model and size

Size W H D	产品型号 Product model (Screw type)				内板型号 Plate Model		金属内板规格 Plate Size	
	ABS 盖:灰色ABS 盒体:灰色ABS Cover:Grey ABS Body:Grey ABS	PC/ABS 盖:透明PC 盒体:灰色ABS Cover:Transparent PC Body:Grey ABS	PC 盖:灰色PC 盒体:灰色PC Cover:Grey PC Body:Grey PC	PC 盖:透明PC 盒体:灰色PC Cover:Transparent PC Body:Grey PC	Plastic(塑料)	Metal(金属)	M1	M2
200 x 300 x 150	TJ-MG-2030-S	TJ-MT-2030-S	TJ-MPG-2030-S	TJ-MPT-2030-S	TJ-2030P	TJ-2030	175	275
200 x 300 x 180	TJ-MG-2030	TJ-MT-2030	TJ-MPG-2030	TJ-MPT-2030	TJ-2030P	TJ-2030	175	275
300 x 300 x 180	TJ-MG-3030	TJ-MT-3030	TJ-MPG-3030	TJ-MPT-3030	TJ-3030P	TJ-3030	275	275
300 x 400 x 180	TJ-MG-3040	TJ-MT-3040	TJ-MPG-3040	TJ-MPT-3040	—	TJ-3040	275	375
400 x 500 x 200	TJ-MG-4050	TJ-MT-4050	TJ-MPG-4050	TJ-MPT-4050	—	TJ-4050	360	460
400 x 600 x 220	TJ-MG-4060	TJ-MT-4060	TJ-MPG-4060	TJ-MPT-4060	—	TJ-4060	355	550

适用附件 Accessories

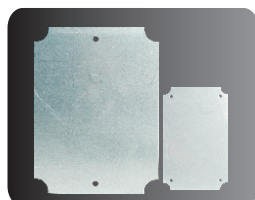

Steel mounting plate
金属底板 (镀锌)

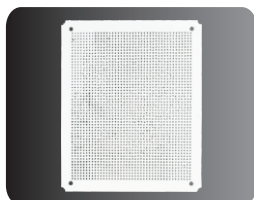

Plastic mounting plate
塑料底板 (ABS)

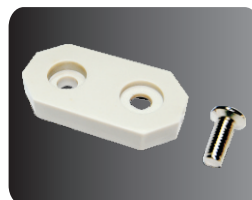

Wall brackets for Big plastic box
塑料盒尼龙挂挂钩
MODEL:MG
Material:nylon
Packing:4pcs/set

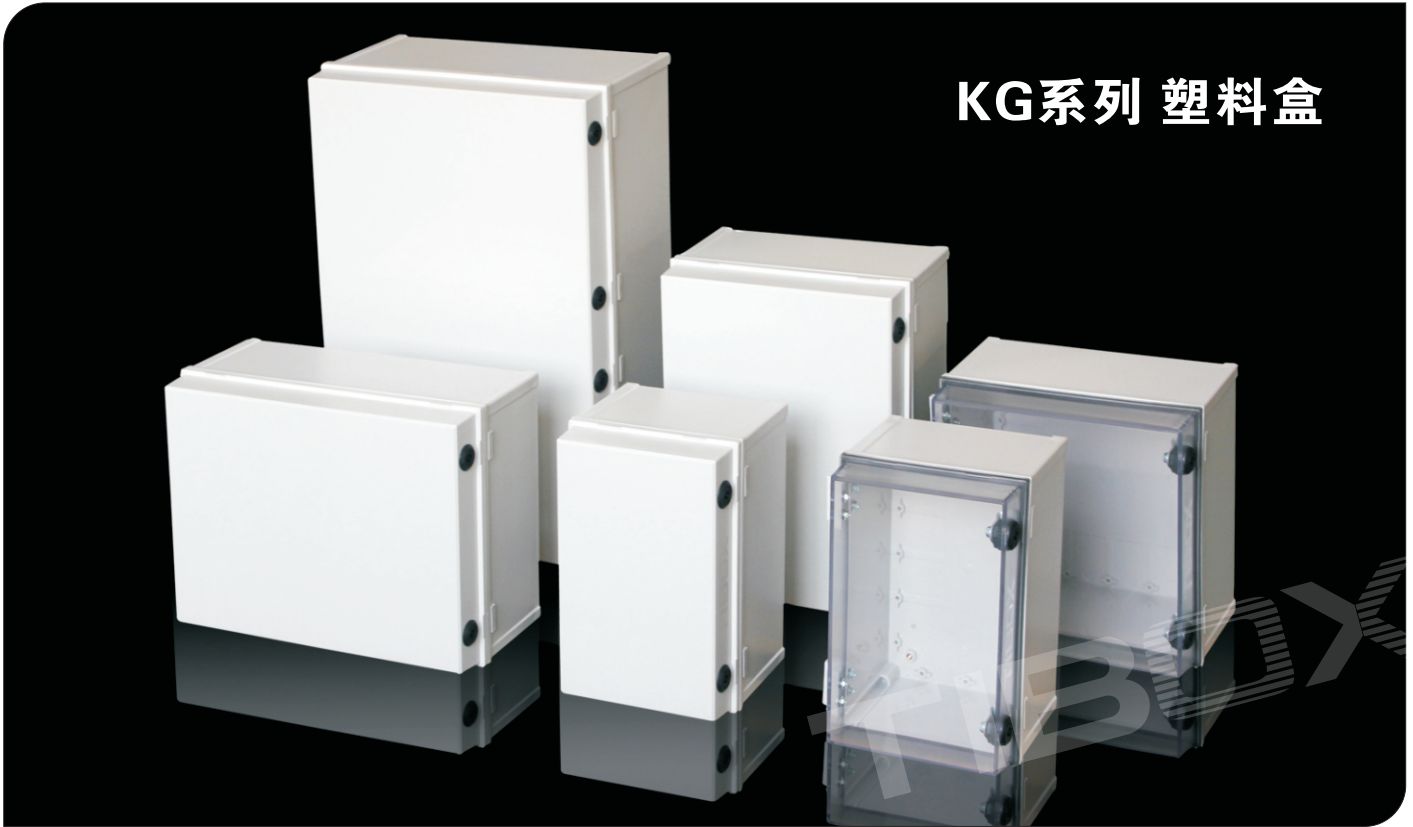

产品特征 Product characteristics



采用高强度ABS、PC耐火材料和UV添加材料制成，外形美观大方，具有很高的可塑性和坚固性。适用于端子箱、配电板、仪器盒、电力设备用BOX以及控制箱作用方便。

With high strength ABS, PC refractories and UV added material, the enclosure has beautiful appearance, high plasticity and ruggedness. It is Suitable for terminal boxes, distribution panels, instrument boxes, electrical equipment boxes and control boxes, simple and easy to use.

型号规格 Model and size

Size W H D	产品型号 Product model (Screw type)				内板型号 Plate Model		金属内板规格 Plate Size	
	ABS 盖:灰色ABS 盒体:灰色ABS Cover:Grey ABS Body:Grey ABS	PC/ABS 盖:透明PC 盒体:灰色ABS Cover:Transparent PC Body:Grey ABS	PC 盖:灰色PC 盒体:灰色PC Cover:Grey PC Body:Grey PC	PC 盖:透明PC 盒体:灰色PC Cover:Transparent PC Body:Grey PC	Plastic(塑料)	Metal(金属)	M1	M2
200 x 300 x 150	TJ-KG-2030-S	TJ-KT-2030-S	TJ-KPG-2030-S	TJ-KPT-2030-S	TJ-2030P	TJ-2030	175	275
200 x 300 x 180	TJ-KG-2030	TJ-KT-2030	TJ-KPG-2030	TJ-KPT-2030	TJ-2030P	TJ-2030	175	275
300 x 300 x 180	TJ-KG-3030	TJ-KT-3030	TJ-KPG-3030	TJ-KPT-3030	TJ-3030P	TJ-3030	275	275
300 x 400 x 180	TJ-KG-3040	TJ-KT-3040	TJ-KPG-3040	TJ-KPT-3040	—	TJ-3040	275	375
400 x 500 x 200	TJ-KG-4050	TJ-KT-4050	TJ-KPG-4050	TJ-KPT-4050	—	TJ-4050	360	460
400 x 600 x 220	TJ-KG-4060	TJ-KT-4060	TJ-KPG-4060	TJ-KPT-4060	—	TJ-4060	355	550

适用附件 Accessories

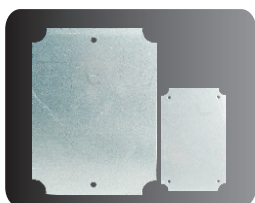

Steel mounting plate
金属底板 (镀锌)

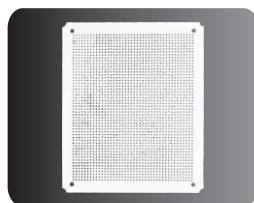

Plastic mounting plate
塑料底板 (ABS)



Cap for Screw
堵塞头
MODEL:ZC-S10

TG系列 塑料盒(金属扣+铰链型)

TG Series Plastic Enclosure(Metal latch+hinge type)

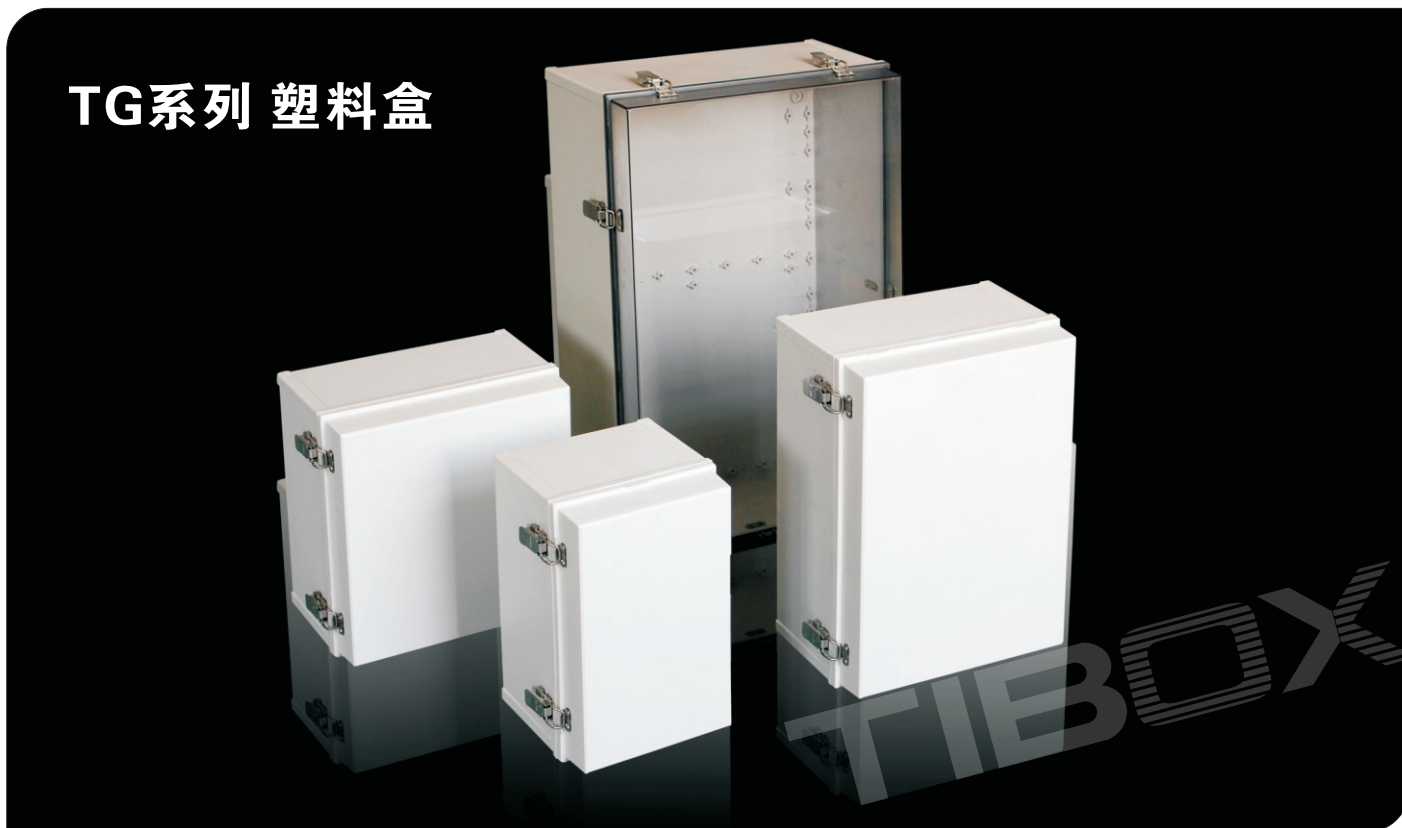

产品特征 Product characteristics



采用高强度ABS、PC耐火材料和UV添加材料制成，外形美观大方，具有很高的可塑性和坚固性。适用于端子箱、配电板、仪器盒、电力设备用BOX以及控制箱作用方便。

With high strength ABS, PC refractories and UV added material, the enclosure has beautiful appearance, high plasticity and ruggedness. It is Suitable for terminal boxes, distribution panels, instrument boxes, electrical equipment boxes and control boxes, simple and easy to use.

型号规格 Model and size

Size W H D	产品型号 Product model (Screw type)				内板型号 Plate Model		金属内板规格 Plate Size	
	ABS 盖:灰色ABS 盒体:灰色ABS Cover:Grey ABS Body:Grey ABS	PC/ABS 盖:透明PC 盒体:灰色ABS Cover:Transparent PC Body:Grey ABS	PC 盖:灰色PC 盒体:灰色PC Cover:Grey PC Body:Grey PC	PC 盖:透明PC 盒体:灰色PC Cover:Transparent PC Body:Grey PC	Plastic(塑料)	Metal(金属)	M1	M2
200 x 300 x 150	TJ-TG-2030-S	TJ-TT-2030-S	TJ-TPG-2030-S	TJ-TPT-2030-S	TJ-2030P	TJ-2030	175	275
200 x 300 x 180	TJ-TG-2030	TJ-TT-2030	TJ-TPG-2030	TJ-TPT-2030	TJ-2030P	TJ-2030	175	275
300 x 300 x 180	TJ-TG-3030	TJ-TT-3030	TJ-TPG-3030	TJ-TPT-3030	TJ-3030P	TJ-3030	275	275
300 x 400 x 180	TJ-TG-3040	TJ-TT-3040	TJ-TPG-3040	TJ-TPT-3040	—	TJ-3040	275	375
400 x 500 x 200	TJ-TG-4050	TJ-TT-4050	TJ-TPG-4050	TJ-TPT-4050	—	TJ-4050	360	460
400 x 600 x 220	TJ-TG-4060	TJ-TT-4060	TJ-TPG-4060	TJ-TPT-4060	—	TJ-4060	355	550

适用附件 Accessories

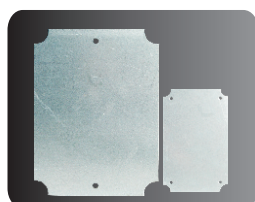

Steel mounting plate
金属底板 (镀锌)

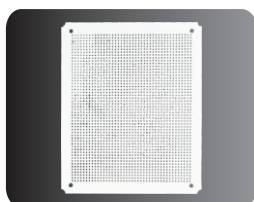

Plastic mounting plate
塑料底板 (ABS)



Stainless steel latch
不锈钢搭扣
MODEL:LC-02



Dimension(允许误差 ± 1mm)

防水防尘等级	IP 66
温度范围	-40°C~+80°C

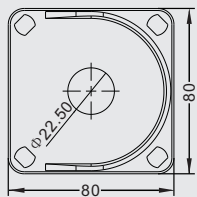

TJ-AG 0808-Q1

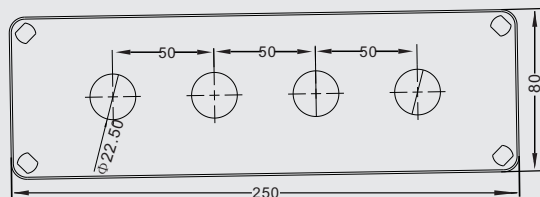

TJ-AG 0825-K4

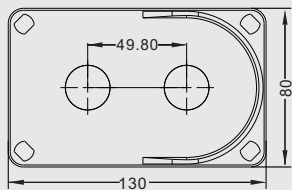

TJ-AG 0813-Q2

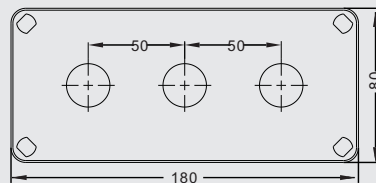

TJ-AG 0818-K3

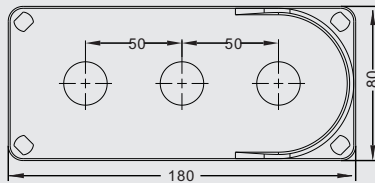

TJ-AG 0818-Q3

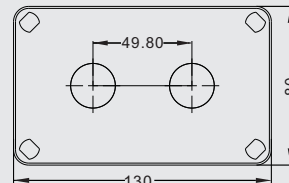

TJ-AG 0808-K2

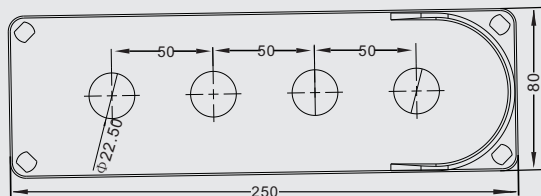

TJ-AG 0825-Q4

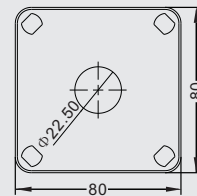

TJ-AG 0813-K1

Size	产品型号
W H D	Product model
80×80×60	TJ-AG 0808-Q1
80×130×70	TJ-AG 0813-Q2
80×180×70	TJ-AG 0818-Q3
80×250×70	TJ-AG 0825-Q4
80×80×60	TJ-AG 0808-K1
80×130×70	TJ-AG 0813-K2
80×180×70	TJ-AG 0818-K3
80×250×70	TJ-AG 0825-K4



TIBOX[®]

TIANQI ELECTRIC



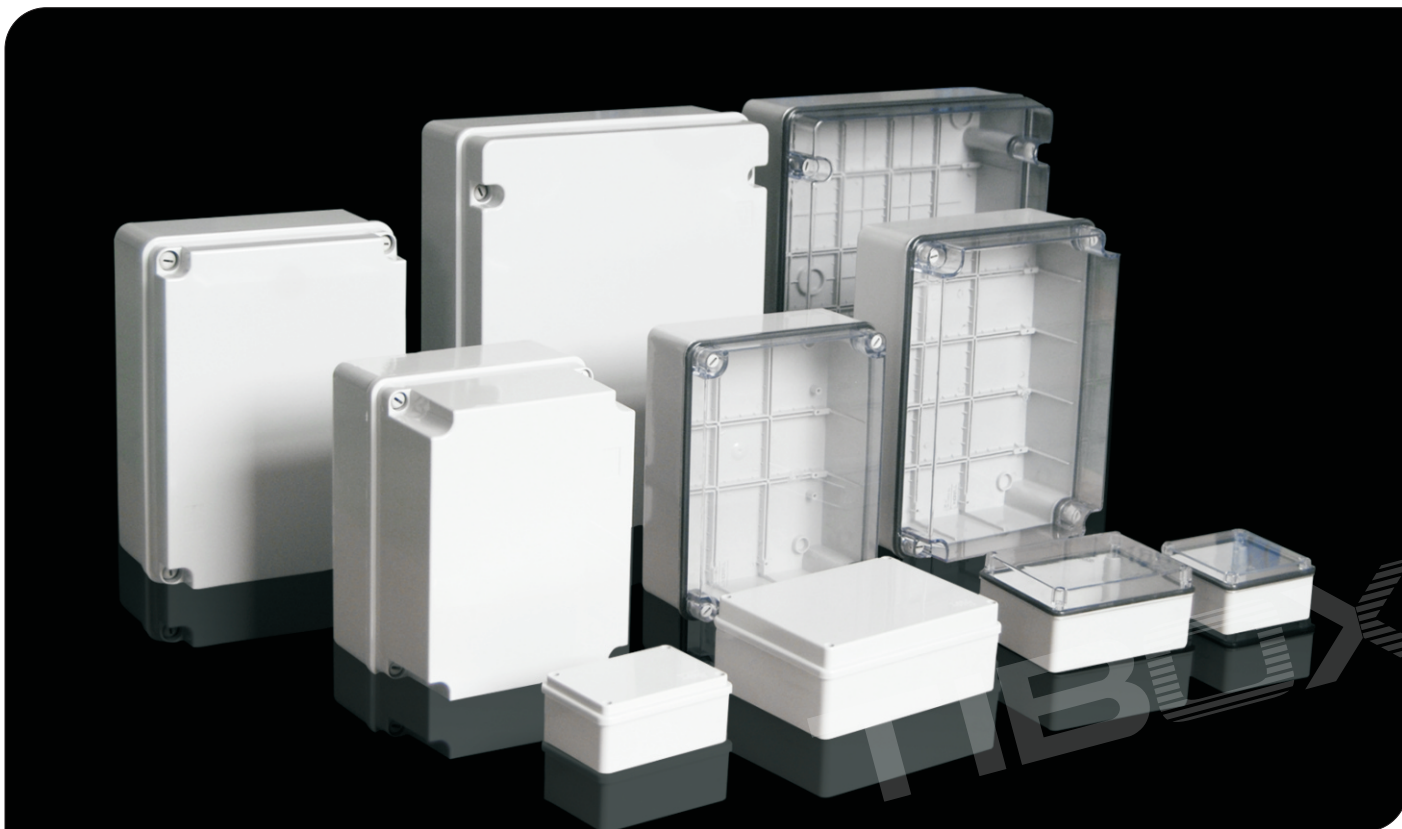

Dimension(允许误差 ± 1mm)

防水防尘等级 IP 66
温度范围 -40°C~+80°C

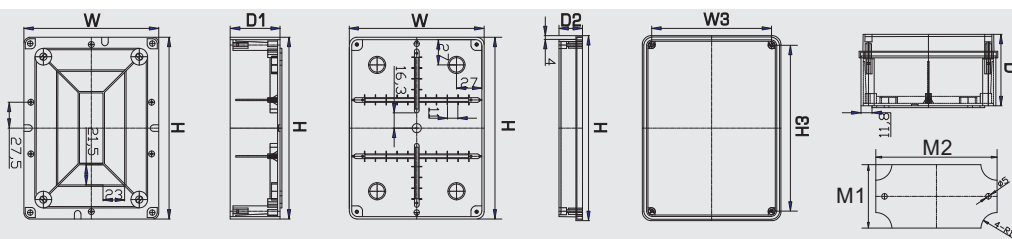

Size	产品型号 Product model (Plastic latch+hinge type)								内板型号 Plate Model		金属内板规格 Plate Size				
	W	H	D	W ₃	H ₃	D ₁	D ₂	ABS 盖:灰色ABS 本体:灰色ABS	PC/ABS 盖:透明PC 本体:灰色ABS	PC 盖:灰色PC 本体:灰色PC	PC 盖:透明PC 本体:灰色PC	Plastic(塑料)	Metal(金属)	M1	M2
80 × 120 × 50	83	124	50	88	88	40	14	TB-AG-0812	TB-AT-0812	TB-PG-0812	TB-PT-0812	—	TJ-0812	73	113
100 × 100 × 50	104	104	50	68	108	40	14	TB-AG-1010	TB-AT-1010	TB-PG-1010	TB-PT-1010	—	TJ-1010	98	98
110 × 150 × 70	113	153	70	98	137	49	25	TB-AG-1115	TB-AT-1115	TB-PG-1115	TB-PT-1115	—	TJ-1115	106	146
140 × 190 × 70	144	194	70	128	177	51	25	TB-AG-1419	TB-AT-1419	TB-PG-1419	TB-PT-1419	—	TJ-1419	126	176
190 × 240 × 90	195	250	90	170	226	70	25	TB-AG-1924	TB-AT-1924	TB-PG-1924	TB-PT-1924	—	TJ-1924	178	232
190 × 240 × 160	195	250	160	170	226	70	96	TB-AG-1924-1	TB-AT-1924-1	TB-PG-1924-1	TB-PT-1924-1	—	TJ-1924-1	178	232
220 × 300 × 120	230	310	120	200	280	76	50	TB-AG-2230	TB-AT-2230	TB-PG-2230	TB-PT-2230	—	TJ-2230	210	290
300 × 380 × 120	310	390	120	281	278	78	50	TB-AG-3038	TB-AT-3038	TB-PG-3038	TB-PT-3038	—	TJ-3038	293	373
300 × 380 × 160	310	390	160	281	278	78	90	TB-AG-3038-1	TB-AT-3038-1	TB-PG-3038-1	TB-PT-3038-1	—	TJ-3038	293	373

TB接线盒塑料盒



安装底板

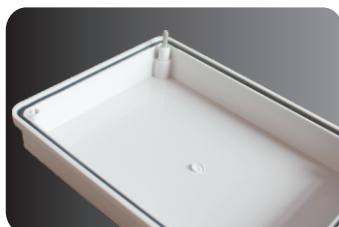

TB-AG-0812~TB-AG-1115金属螺丝



TB-AG-1419~TB-AG-3038塑料螺丝



可90°开启

TB系列 塑料盒

TB Series Plastic Enclosure



Beautiful appearance, excellent processing and stability should be guaranteed by material such as High Intensity ABS, PC, AC polyester assured Flammability material and Glass 30% annexing material. The use is convenient for the installation of Terminal Box, the supply Switchboard, Apparatus Box, electrical power supply and Control Box etc.

防水防尘等级	IP 55
温度范围	-40°C~+80°C

Size	产品型号 Product model (Plastic latch+hinge type)						内板型号 Plate Model		金属内板规格 Plate Size		
	W	H	D	D ₁	D ₂	ABS	PC/ABS	Plastic(塑料)	Metal(金属)	M1	M2
						盖:灰色ABS 盒体:灰色ABS Cover:Grey ABS Body:Grey ABS	盖:透明PC 盒体:灰色ABS Cover:Transparent PC Body:Grey ABS				
φ60×45	—	—	—	—	—	TB-AGR-C60	TB-ATR-C60	—	—	—	—
φ70×48	—	—	—	—	—	TB-AGR-C70	TB-ATR-C70	—	—	—	—
75×75×45	75	75	45	41.7	10	TB-AGR-0606	TB-ATR-0606	—	—	—	—
89×89×50	89	89	50	46.5	10	TB-AGR-0808	TB-ATR-0808	—	—	—	—
80×120×50	83	124	50	40	14	TB-AGR-0812	TB-ATR-0812	—	TJ-0812	73	113
100×100×50	104	104	50	40	14	TB-AGR-1010	TB-ATR-1010	—	TJ-1010	98	98
110×150×70	113	153	70	49	25	TB-AGR-1115	TB-ATR-1115	—	TJ-1115	106	146
140×190×70	144	194	70	51	25	TB-AGR-1419	TB-ATR-1419	—	TJ-1419	126	176
190×240×90	195	250	90	70	25	TB-AGR-1924	TB-ATR-1924	—	TJ-1924	178	232
190×240×160	195	250	160	70	96	TB-AGR-1924-1	TB-ATR-1924-1	—	TJ-1924-1	178	232
220×300×120	230	310	120	76	50	TB-AGR-2230	TB-ATR-2230	—	TJ-2230	210	290
300×380×120	310	390	120	76	50	TB-AGR-3038	TB-ATR-3038	—	TJ-3038	293	373
300×380×160	310	390	160	70	96	TB-AGR-3038-1	TB-ATR-3038-1	—	TJ-3038-1	293	373



TB Series Plastic Enclosure

Dimension(允许误差 ± 1mm)

防水防尘等级 IP 66

温度范围 -40°C+80°C

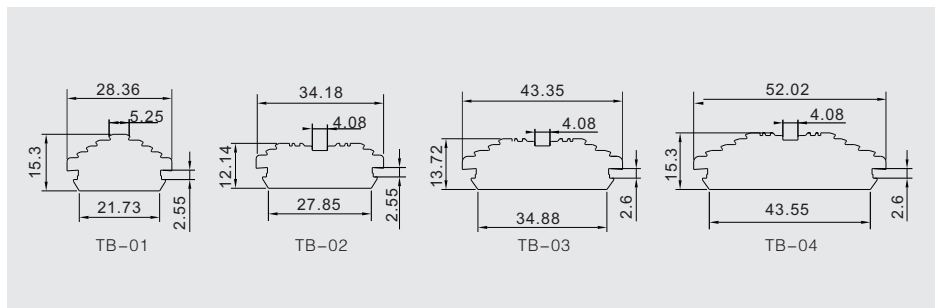
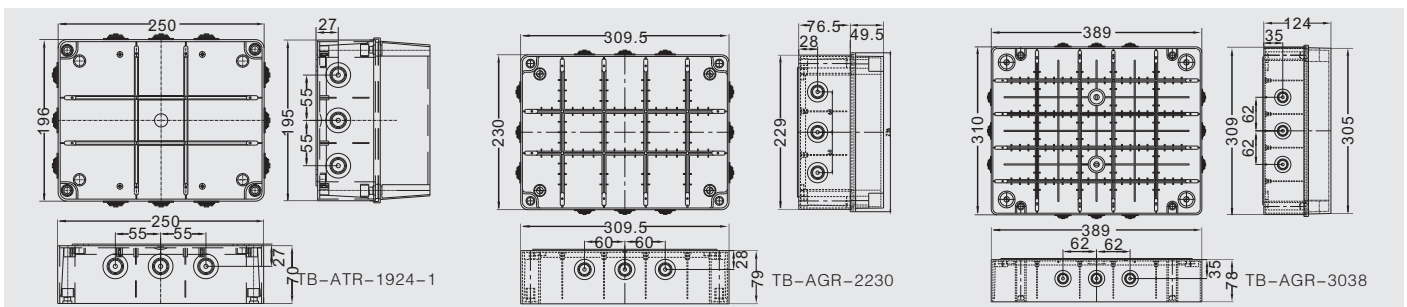
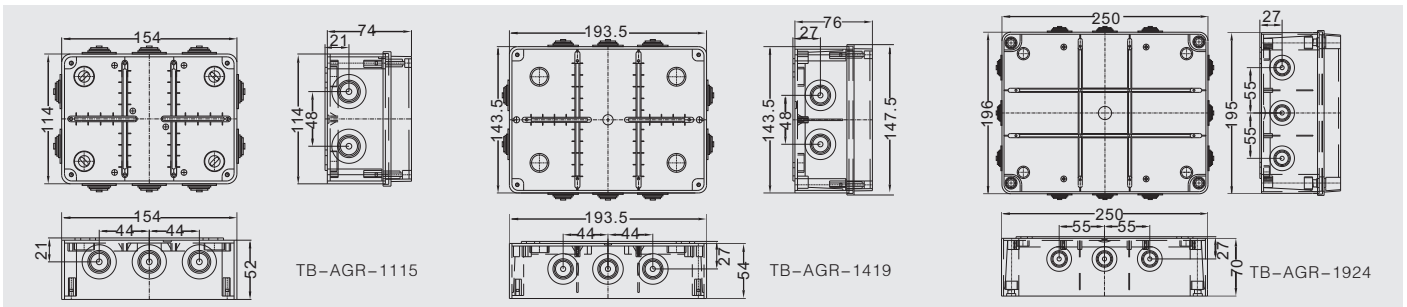
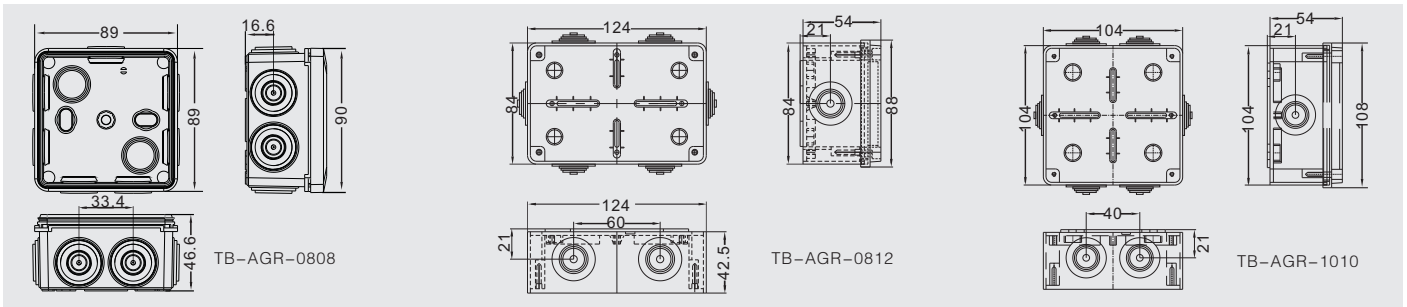
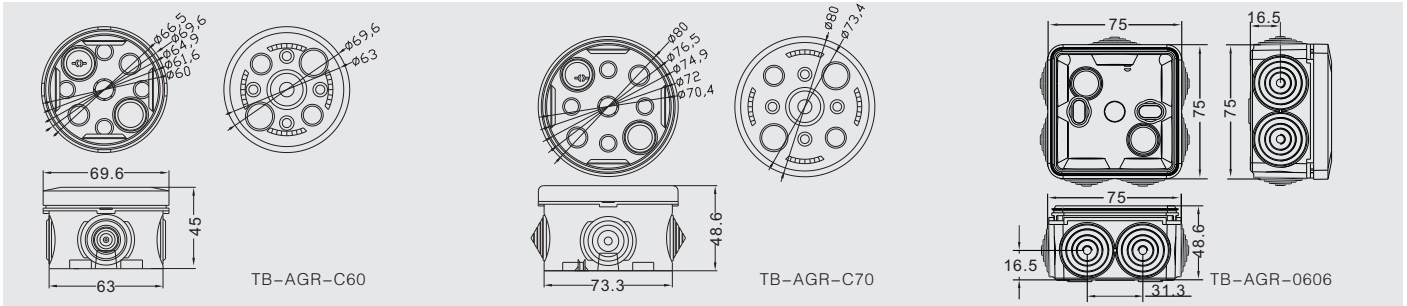

TJ系列 塑料盒

TJ Series Plastic Enclosure

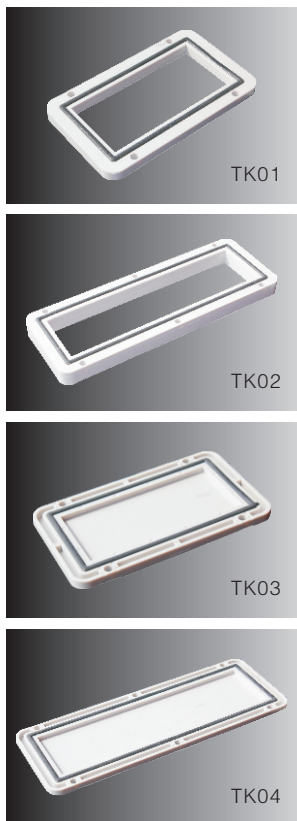
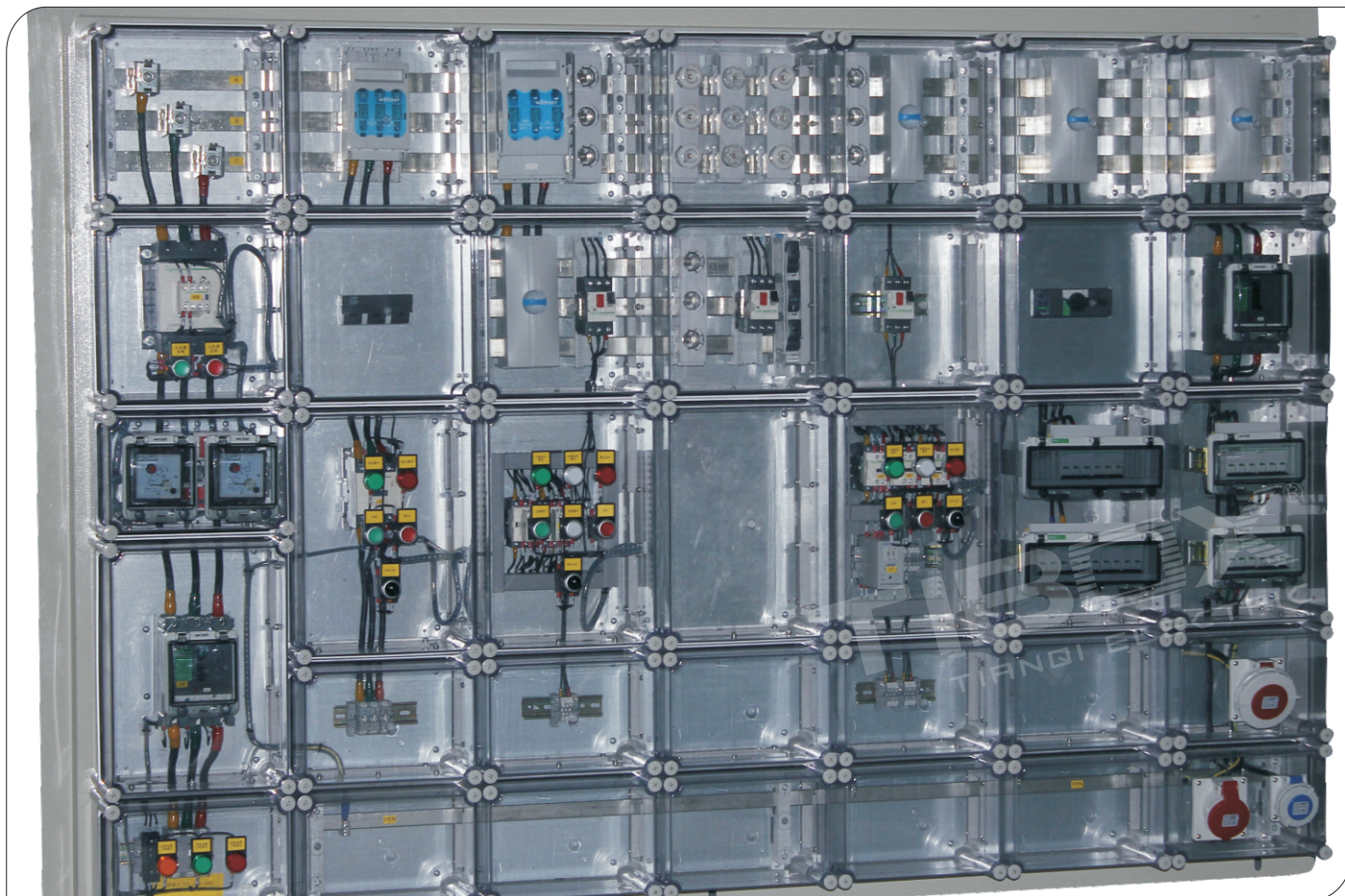

190	2819-K1	3819-K1	2819-K1	2819-K1	190
280	2828-K1	3828-K1	2856-K1		280
190	2819-K1	3819-K1	3856-K1		380
190	2819-K1	3819-K1			
	280	380	560		

TJ Series Plastic Enclosure

2819-K1	2819-K2	2819-K3	2819-K4	2819-K5	2819-K6	2819-K7
2828-K1	2828-K2	2828-K3	2828-K4	2828-K5	2828-K6	2828-K7
3819-K1	3819-K2	3819-K3	3819-K4	3819-K5	3819-K6	3819-K7
3828-K1	3828-K2	3828-K3	3828-K4	3828-K5	3828-K6	3828-K7
2856-K1	2856-K2	2856-K3	2856-K4	2856-K5	2856-K6	2856-K7
3856-K1	3856-K2	3856-K3	3856-K4	3856-K5	3856-K6	3856-K7

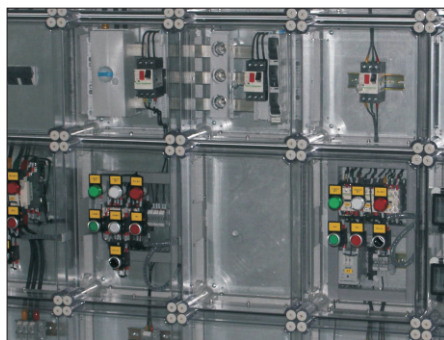
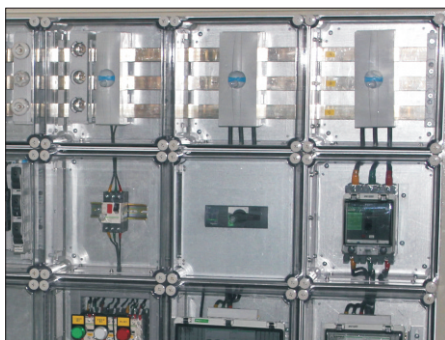

端子接线盒

Terminal Block Box

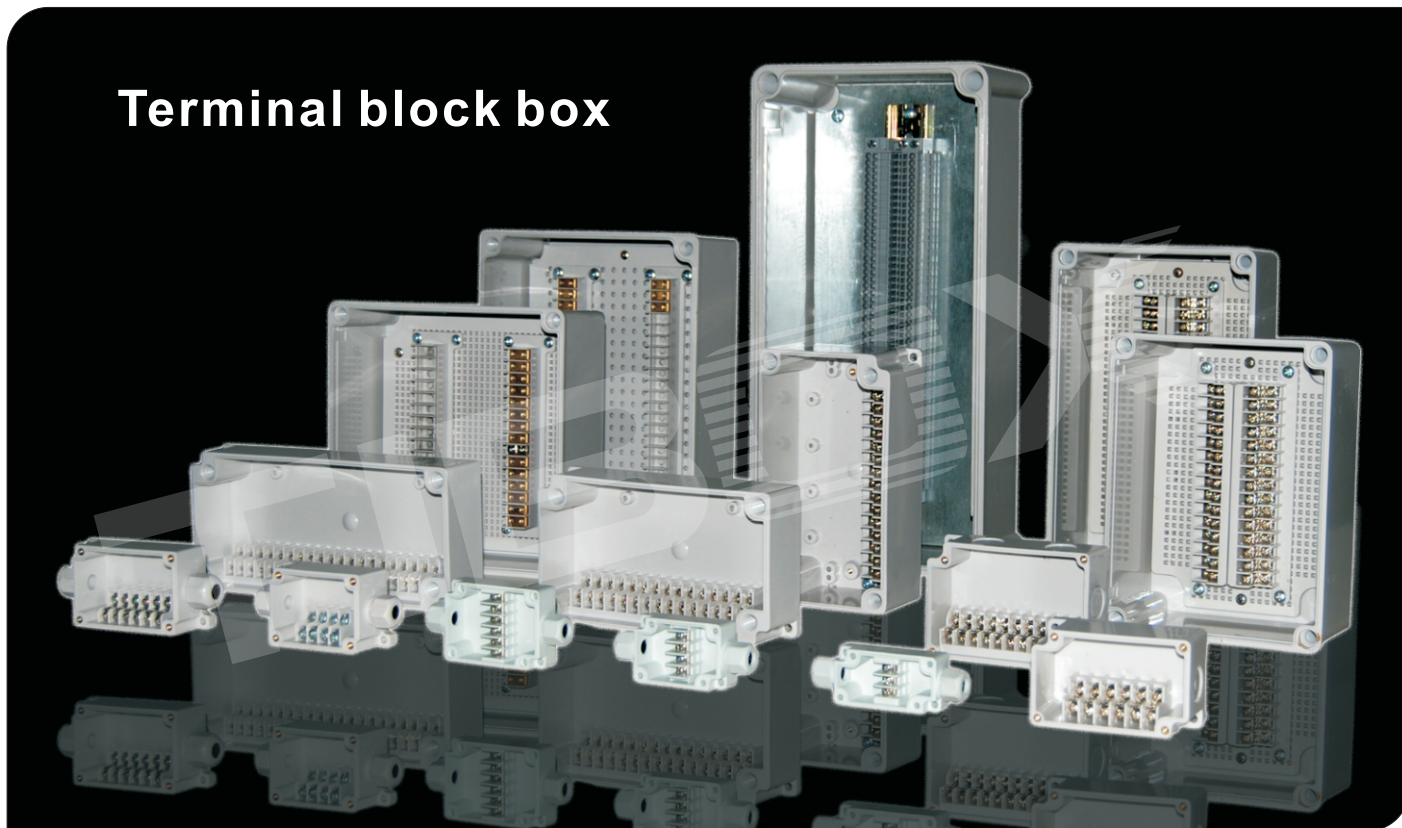

端子盒有极好的绝缘性能，抗化学腐蚀和抗机械挤压的性能。达到高要求的IP66防护等级。所有的箱体都防尘、防水，能抗80度高温。产品采用高强度ABS、PC、PBT耐火材料和UV添加材料制成。外形美观大方，具有很高的可塑性和坚固性。接线端子排正常耐压400V，耐压4KV，正常电流容量0.75mm sq.-1.5mm sq.端子规格有3P-60P多种规格满足你的选择。

The terminal block box, it is made by ABS material, Normal voltage: 400V The normal current capacity: 0.75mm sq.-15mm sq.
Temperature range: -40°C to +120°C ABS: Acrylonitrile Butadiene Styrene PC: Poly Carbamate
Product with hole can be used without separate processing

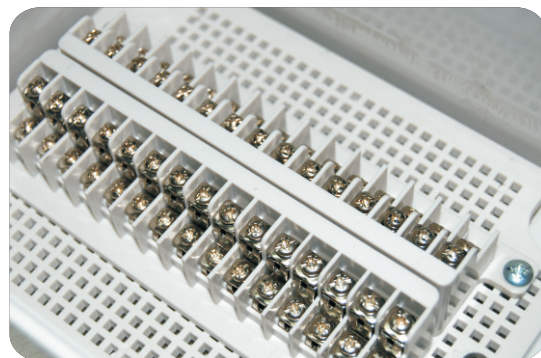

Terminal Block Box

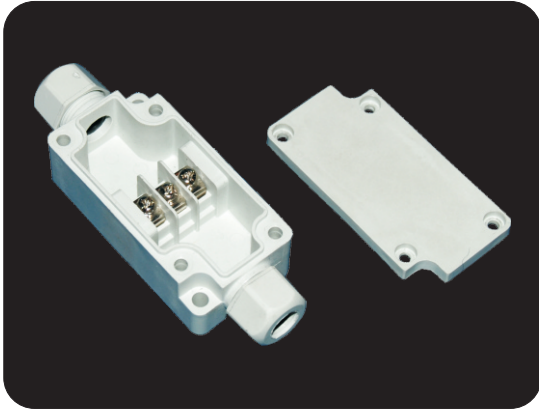

型号 (Model): PBT-3P 尺寸 (Size): 33×65×24mm

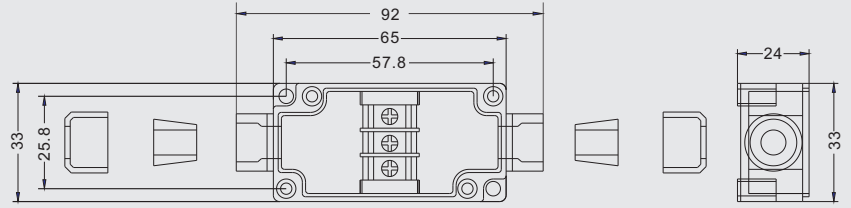

Dimension (允许误差 allowance ±1mm)

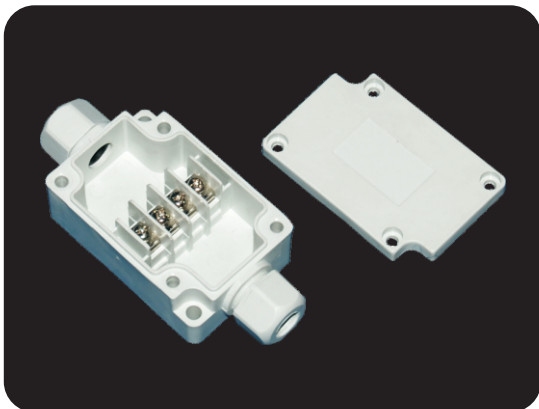

型号 (Model): PBT-4P 尺寸 (Size): 40×60×24mm

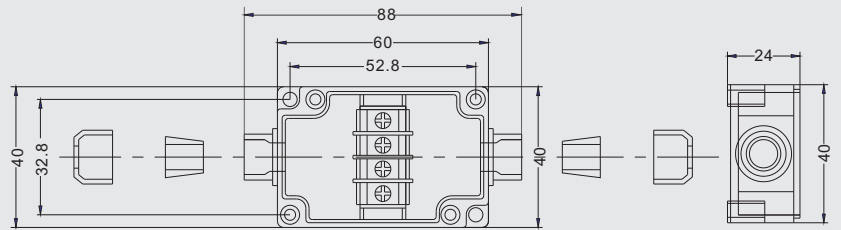

Dimension (允许误差 allowance ±1mm)

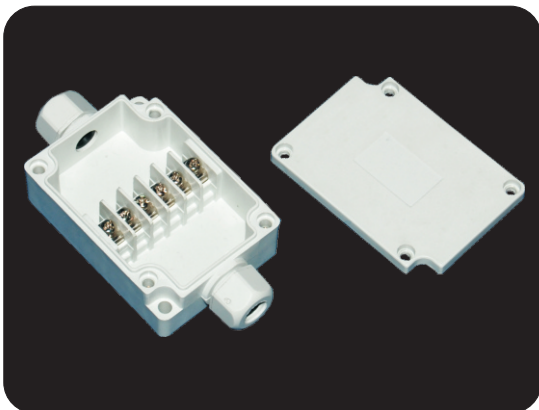

型号 (Model): PBT-6P 尺寸 (Size): 50×70×24mm

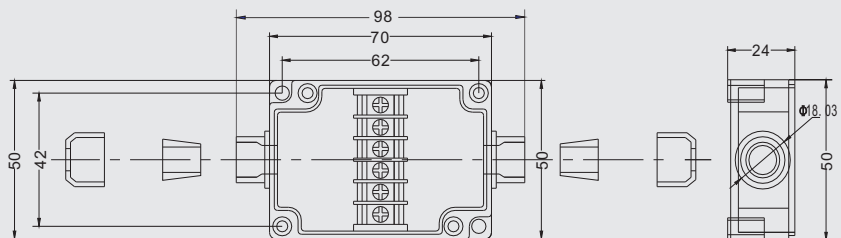

Dimension (允许误差 allowance ±1mm)

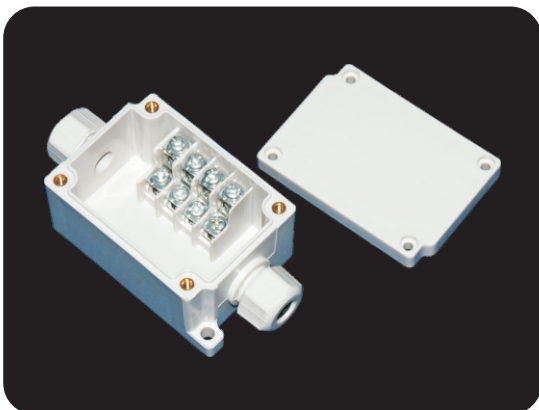

型号 (Model): TJ-4P 尺寸 (Size): 50×102×40mm

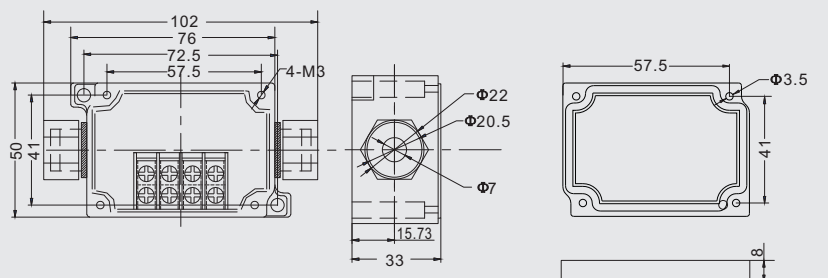

Dimension (允许误差 allowance ±1mm)

端子接线盒

Terminal Block Box

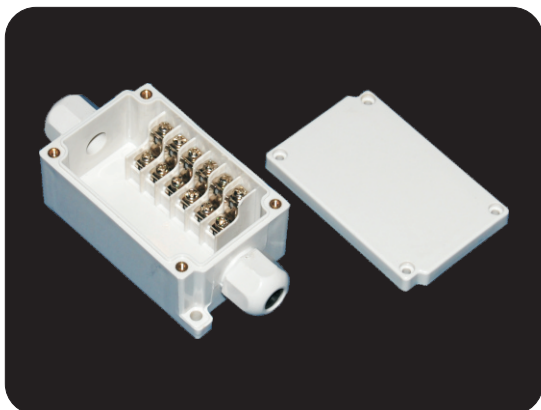

型号 (Model): TJ-6P

尺寸 (Size): 55×125×40mm

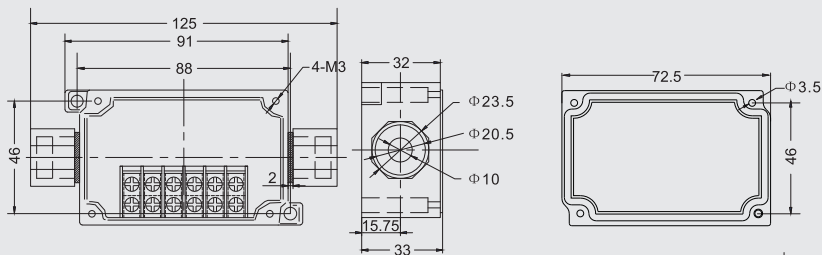

Dimension (允许误差 allowance ±1mm)



型号 (Model): TJ-4P-K

尺寸 (Size): 55×70×43mm

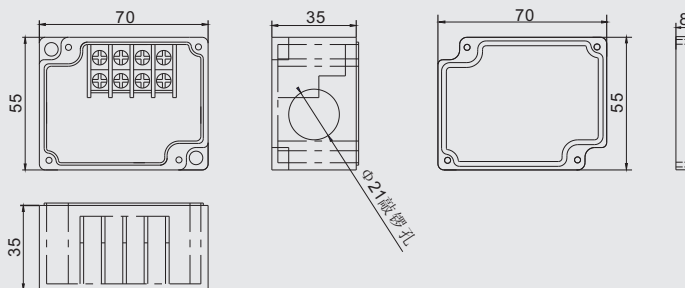

Dimension (允许误差 allowance ±1mm)

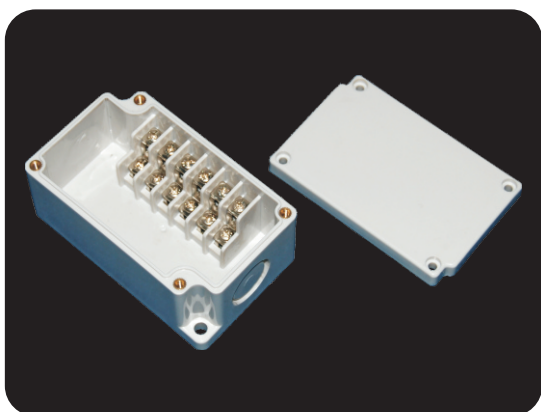

型号 (Model): TJ-6P-K

尺寸 (Size): 55×91×43mm

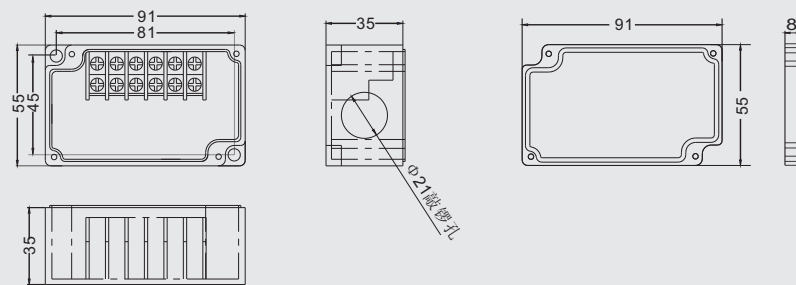

Dimension (允许误差 allowance ±1mm)

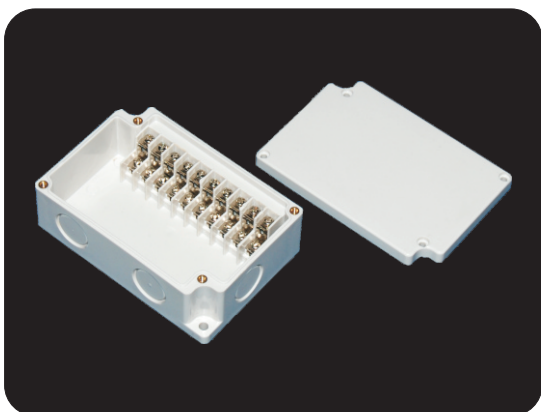

型号 (Model): TJ-10P

尺寸 (Size): 75×110×40mm

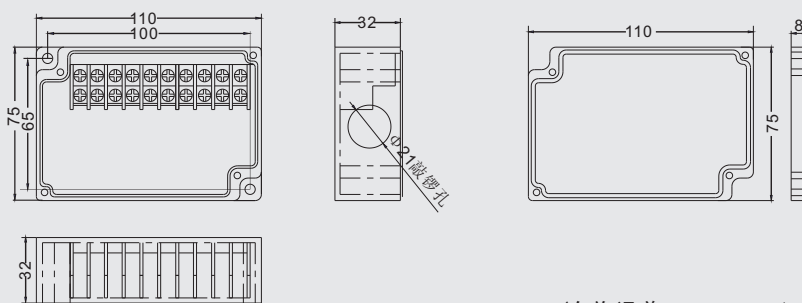

Dimension (允许误差 allowance ±1mm)

Terminal Block Box

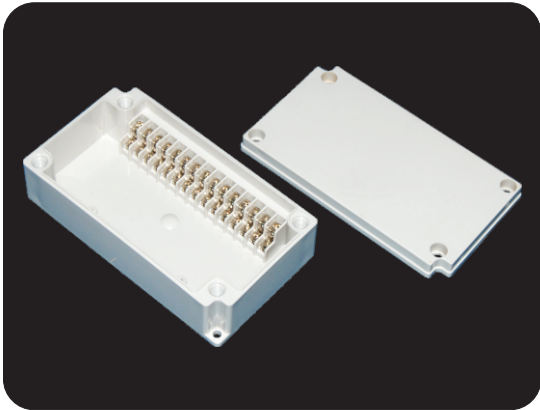

型号 (Model): TJ-15P

尺寸 (Size): 100×180×55mm

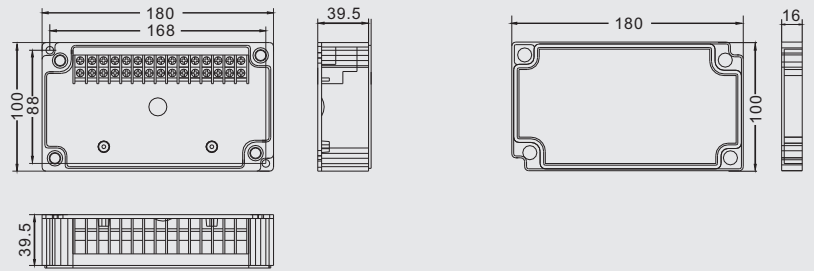

Dimension (允许误差 allowance ±1mm)

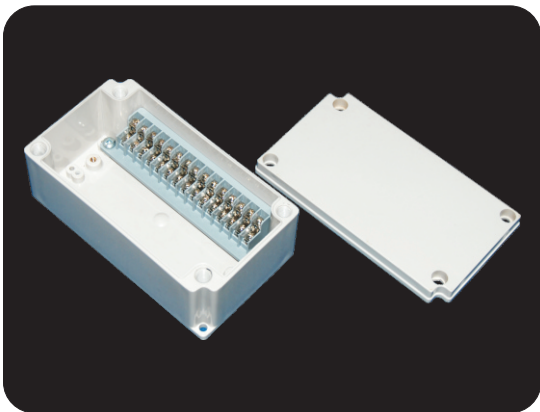

型号 (Model): TJ-15P-S

尺寸 (Size): 100×180×75mm

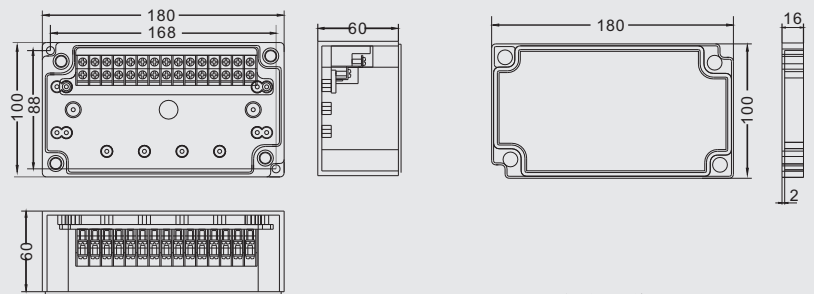

Dimension (允许误差 allowance ±1mm)

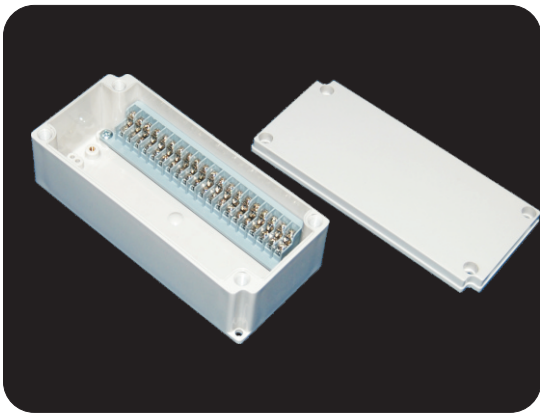

型号 (Model): TJ-20P-S

尺寸 (Size): 100×223×75

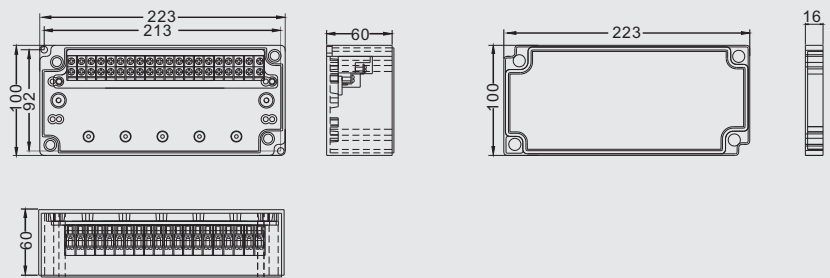

Dimension (允许误差 allowance ±1mm)



型号 (Model): TJ-4P-M

尺寸 (Size): 55×91×43mm

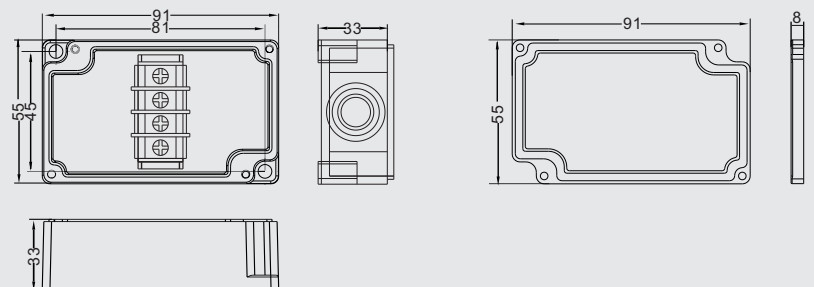

Dimension (允许误差 allowance ±1mm)

端子接线盒

Terminal Block Box



型号 (Model): TJ-6P-M

尺寸 (Size): 75×91×43mm

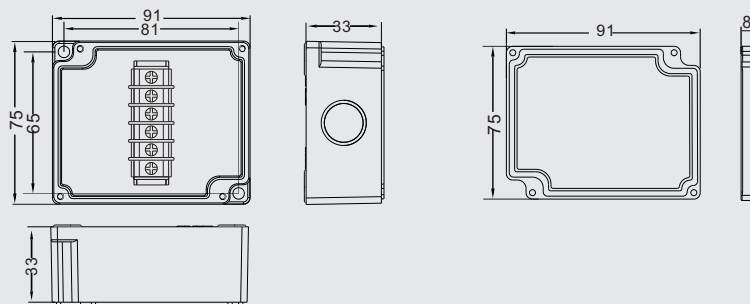

Dimension (允许误差 allowance ±1mm)



型号 (Model): TJ-10P-M

尺寸 (Size): 91×110×43mm

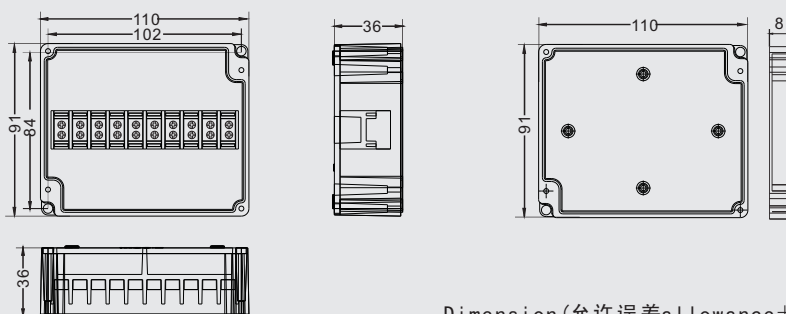

Dimension (允许误差 allowance ±1mm)

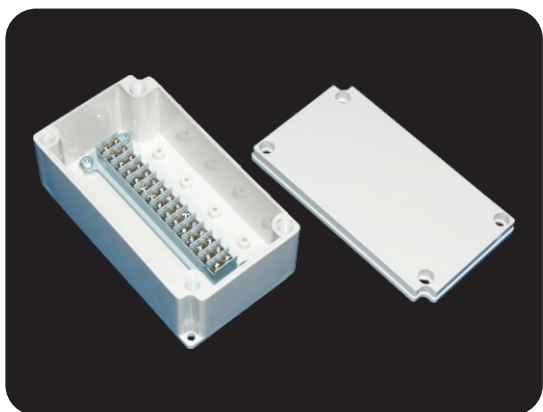

型号 (Model): TJ-15P-M

尺寸 (Size): 100×180×75mm

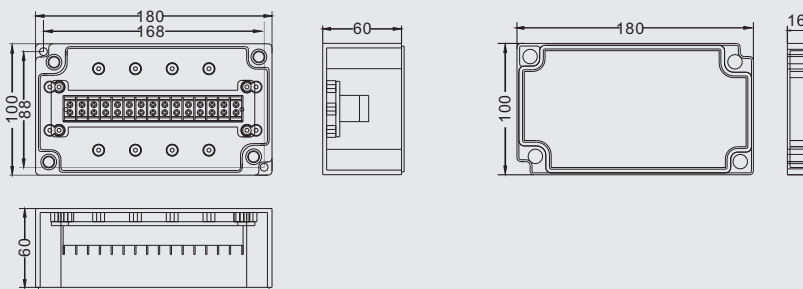

Dimension (允许误差 allowance ±1mm)

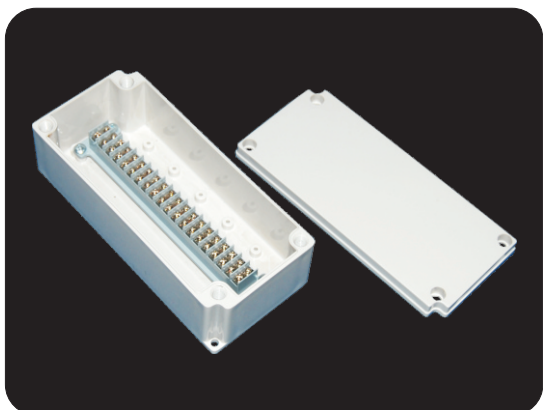

型号 (Model): TJ-20P-M

尺寸 (Size): 100×223×75

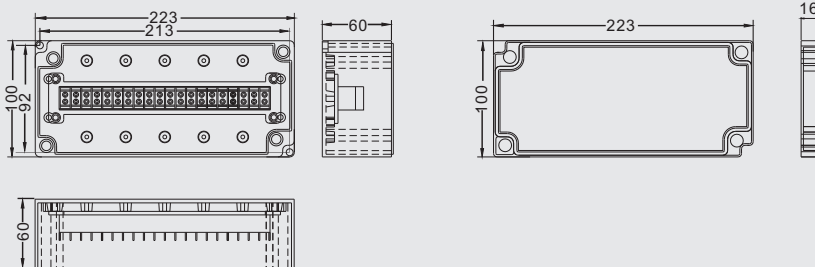

Dimension (允许误差 allowance ±1mm)

Terminal Block Box

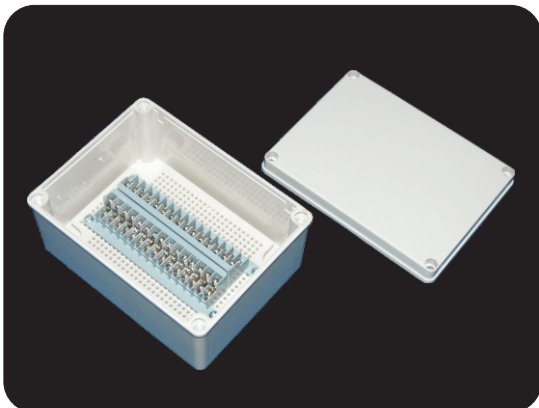

型号 (Model): TJ-30P-S

尺寸 (Size): 150×200×100mm

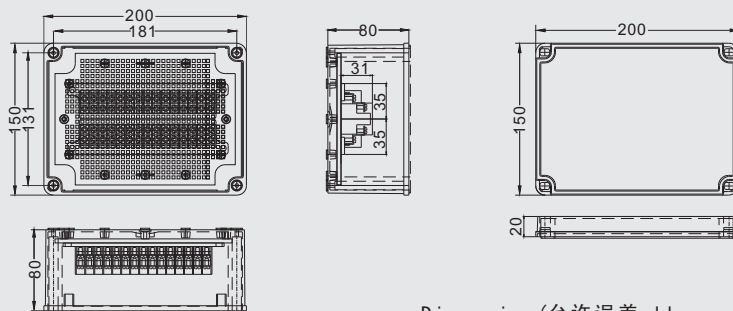

Dimension (允许误差 allowance $\pm 1\text{mm}$)

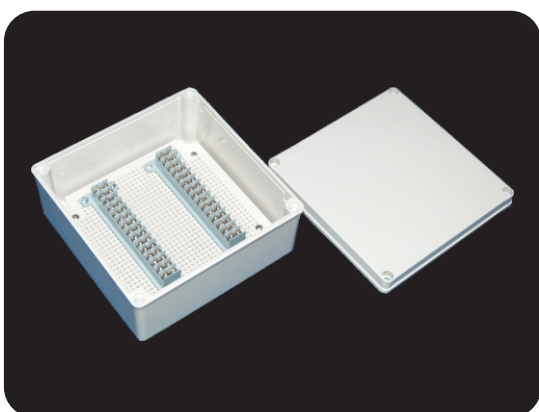

型号 (Model): TJ-30P-M

尺寸 (Size): 200×200×95mm

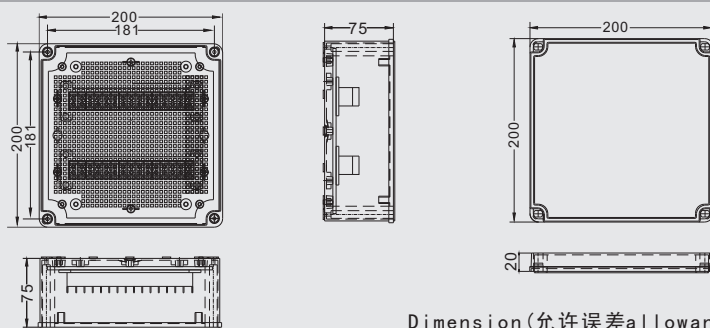

Dimension (允许误差 allowance $\pm 1\text{mm}$)

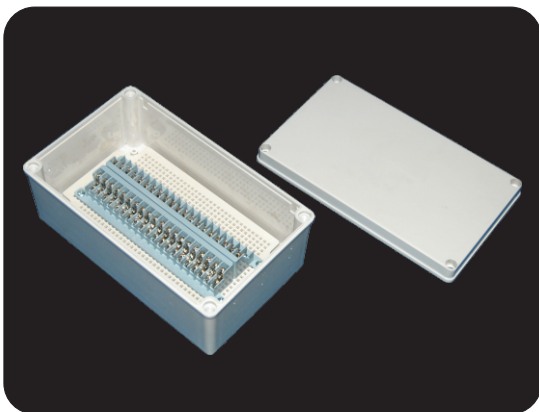

型号 (Model): TJ-40P-S

尺寸 (Size): 150×250×100mm

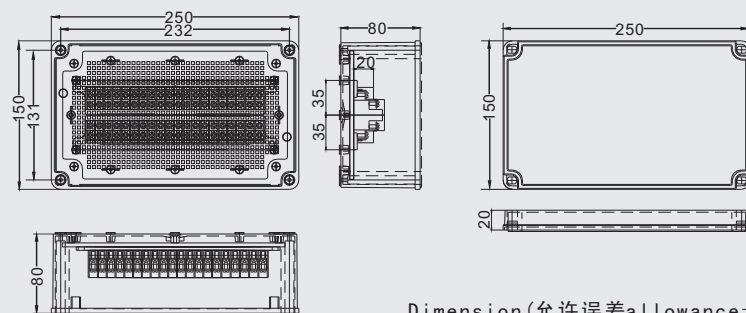

Dimension (允许误差 allowance $\pm 1\text{mm}$)

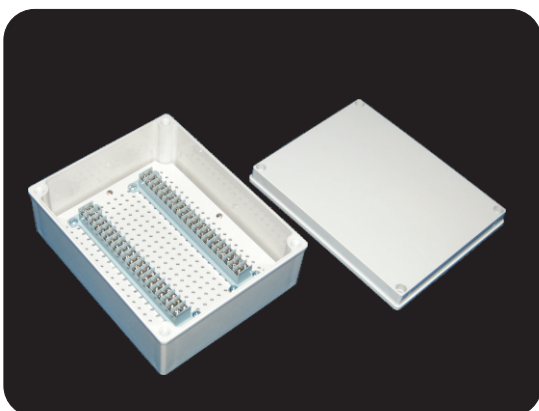

型号 (Model): TJ-40P-M

尺寸 (Size): 200×250×100mm

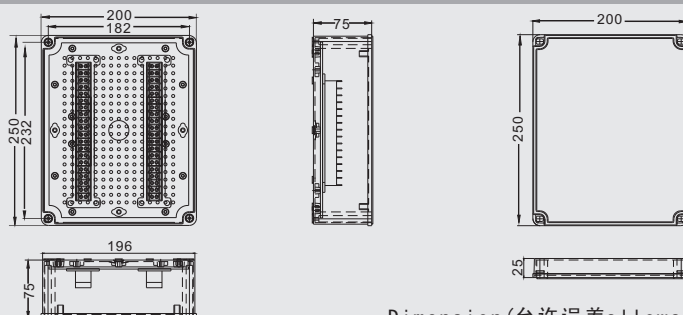

Dimension (允许误差 allowance $\pm 1\text{mm}$)

端子接线盒

Terminal Block Box

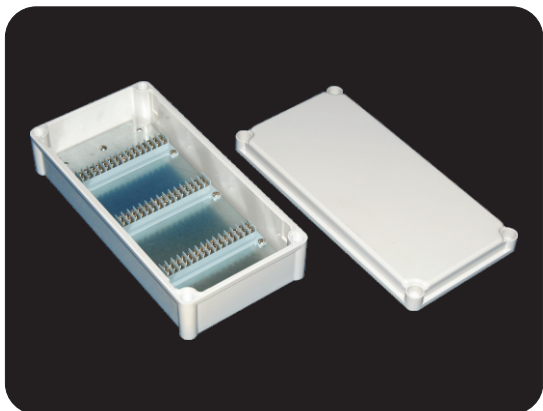

型号(Model): TJ-45P 尺寸(Size): 380 × 190 × 100mm

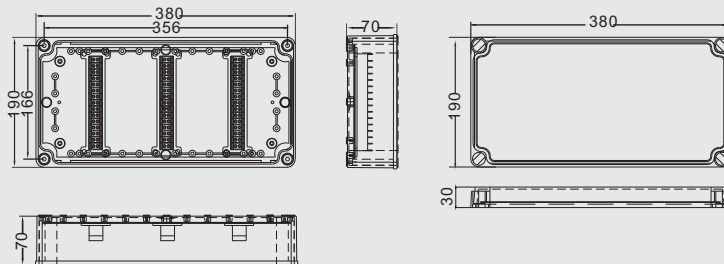

Dimension (允许误差allowance ±1mm)

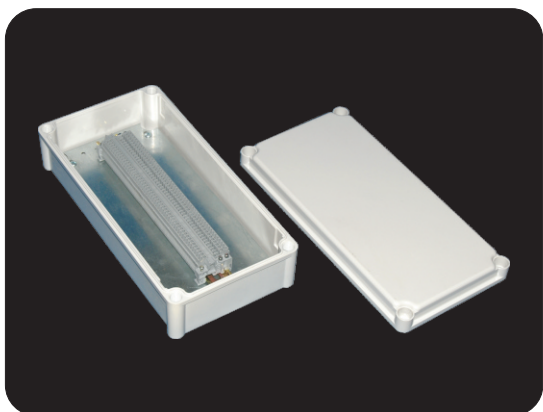

型号(Model): TJ-50P 尺寸(Size): 380 × 190 × 100mm

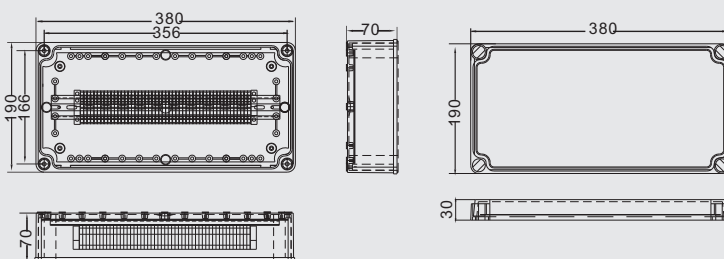

Dimension (允许误差allowance ±1mm)

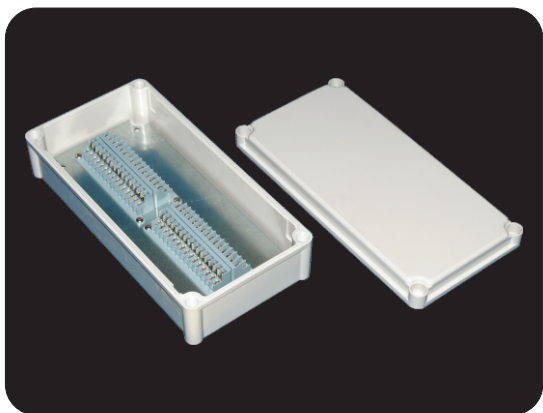

型号(Model): TJ-60P 尺寸(Size): 380 × 190 × 100mm

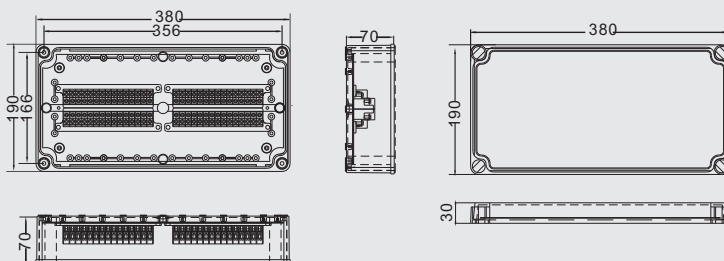

Dimension (允许误差allowance ±1mm)



TB-15P-M

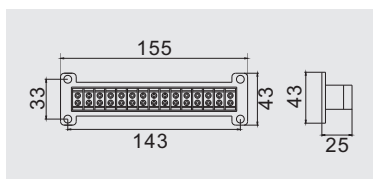

TB-15P-S

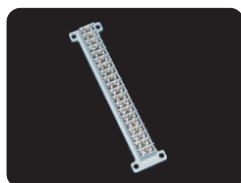
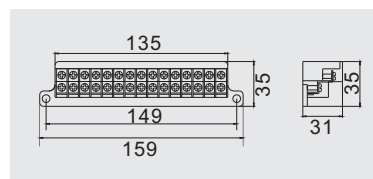

TB-20P-M

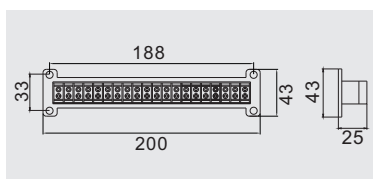

TB-20P-S

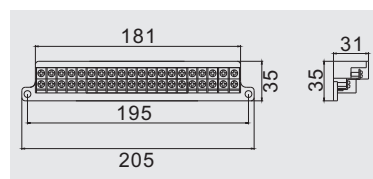

Carving/Printing/Coloring Service

Holl processing service



■ 电刻机加工服务

TIBOX以丰富的经验为基础为客户提供各种要求的冲孔加工服务。

■ Sculpt processing service

TIBOX Inc.meet on customer's variety of request by a sophisticated hole processing technology on the basis of accumulated experience.

Printing service



■ 丝印及文字加工服务

丝印及文字加工印刷服务让你的产品更出色

■ Silk-screen printing and letter sculpturing service

A vivid silk-screen printing and letter sculpturing service make your product outstanding.

development services



■ 非标定制开发服务

根据客户需求，提供多种方案，开发非标产品

■ Non-standard custom development services

According to customer needs, providing a variety of programs, the development of non-standard client

Coloring service



■ 颜色选择服务

按客户要求提供各种颜色的高品质箱体

■ Coloring service

We produce high quality enclosure with a variety of color.

PSM系列 聚酯盒

PSM Series Polyester Box



Dimension(允许误差 ± 1mm)

防水防尘等级 IP 66
温度范围 -40℃~+80℃

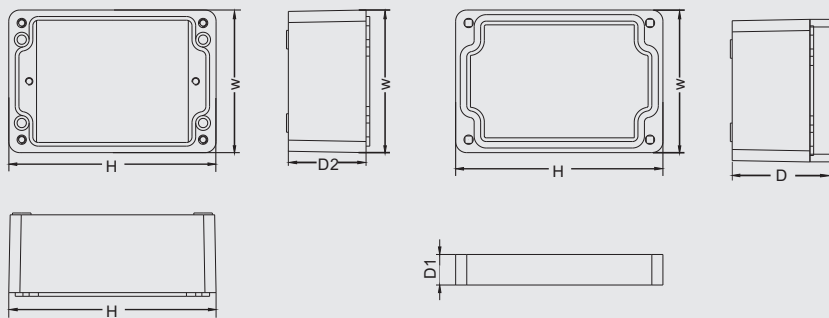

Out of the plastic boxes which are selling at present, it's ability and working efficiency, the competitive power is much higher with the low price same as the level of steel box. The products were added the electromagnetic interference(EMI) and prevent substance of the static electricity, and the strong point was given to the relevant mechanical protection of electricity, electron and etc.

Temperature range:-40 to +120℃

SMC:Fiber glass(body)

PC:Poly Carbamate(cover)

Size	产品型号 Product model (Plastic latch+hinge type)					内板型号 Plate Model	金属内板规格Plate Size		
W H D	W	H	D	D ₁	D ₂	SMC	Metal(金属)	M1	M2
80 x 75 x 55	75	80	55	15	40	PSM-0708	TJ-0708	60	65
110 x 75 x 55	75	110	55	15	40	PSM-0711	TJ-0711	60	95
122 x 120 x 90	120	122	90	25	65	PSM-1212	TJ-1212	105	105
160 x 160 x 90	160	160	90	20	70	PSM-1616	TJ-1616	143	143
160 x 260 x 90	160	260	90	20	70	PSM-1626	TJ-1626	143	243
250 x 250 x 120	250	250	120	25	95	PSM-2525	TJ-2525	233	233
250 x 400 x 120	250	400	120	25	95	PSM-2540	TJ-2540	233	385

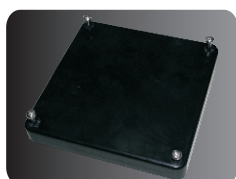
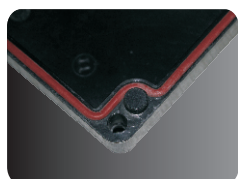

TJ Series Plastic Enclosure(Plastic latch+hinge type)



Dimension(允许误差 ± 1 mm)

防水防尘等级	IP 66
温度范围	-40°C~+80°C

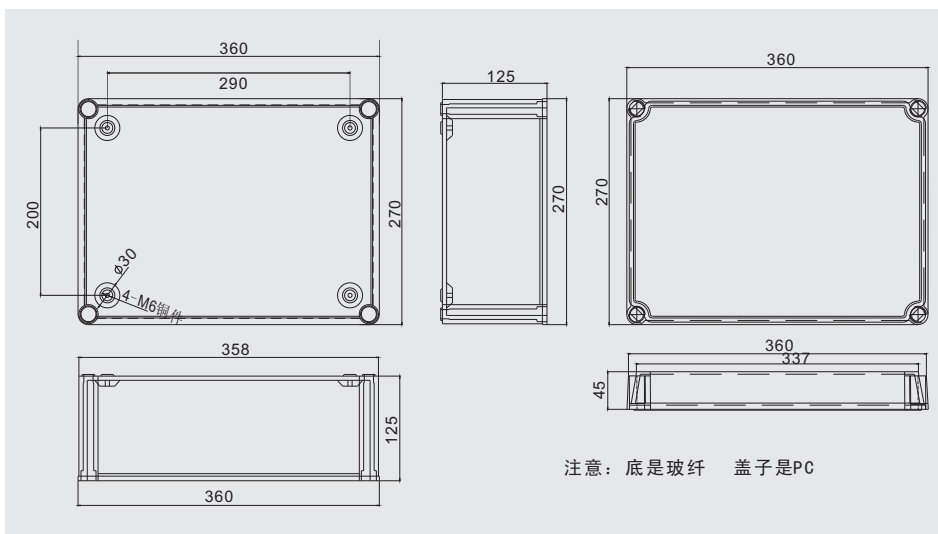

Out of the plastic boxes which are selling at present, it's ability and working efficiency, the competitive power is much higher with the low price same as the level of steel box. The products were added the electromagnetic interference(EMI) and prevent substance of the static electricity, and the strong point was given to the relevant mechanical protection of electricity, electron and etc.

Temperature range:-40 to +120°C

SMC:Fiber glass(body)

PC:Poly Carbamate(cover)

Size	产品型号 Product model (Plastic latch+hinge type)						内板型号 Plate Model		金属内板规格Plate Size		
	W	H	D	D1	D2	PC/TIB		Plastic(玻纤)	Metal(金属)	M1	M2
						盖:灰色PC 盒体:玻纤 Cover:Grey PC Body:Glass fiber	盖:透明PC 盒体:玻纤 Cover:Transparent PC Body:Glass fiber				
270 x 180 x 170	270	180	170	45	125	PSG-2718	PST-2718	TJ-2718	TJ-2718	150	240
360 x 270 x 170	360	270	170	45	125	PSG-3627	PST-3627	TJ-3627	TJ-3627	235	320



Steel mounting plate
金属底板 (镀锌)

玻璃纤维箱

Polyester Enclosure

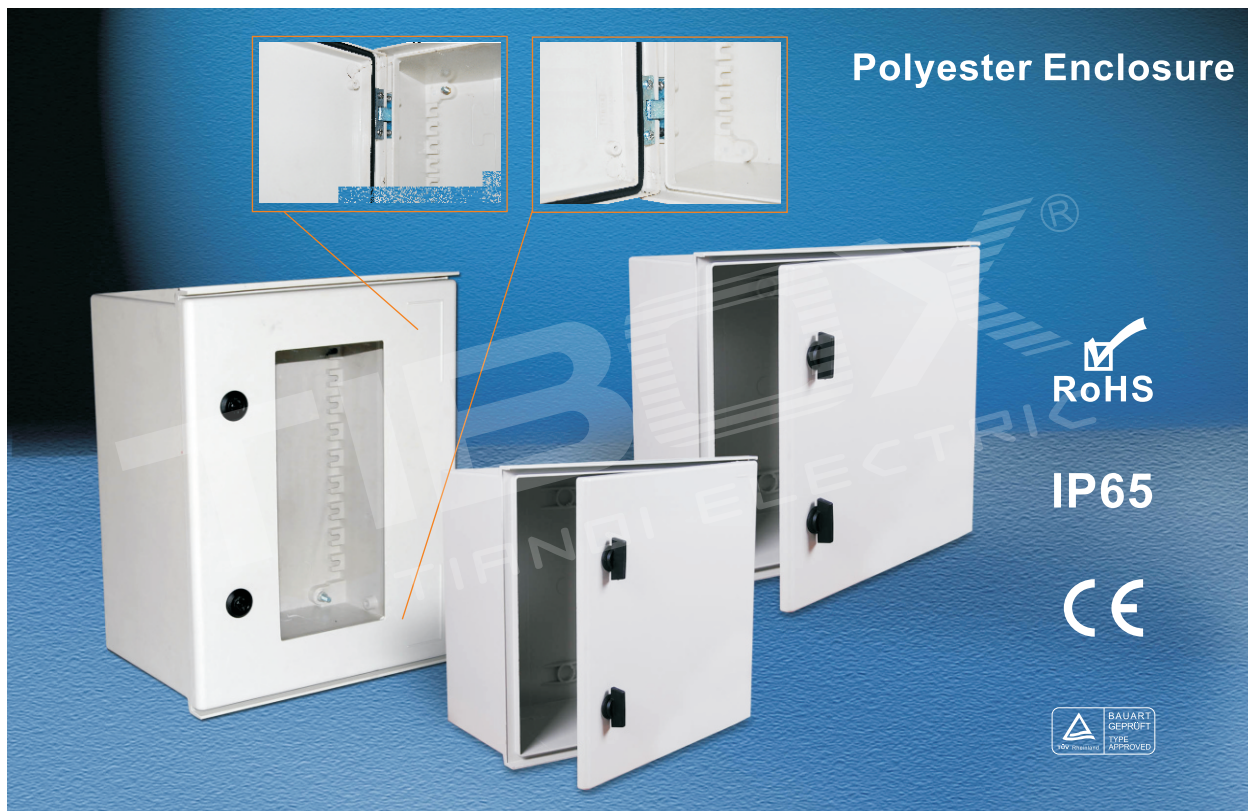

Polyester Enclosure

TIP series are new type, it made by polyesters. The characteristics of the polyesters is its own min 30% fibre glass, make it reached high resistance and mechanical stiffness, have the same effect of metal enclosure which is 3 times heavier than it. Compared with metal enclosure, TIP series are lighter, more adequate for corrosion and dankish environment.

玻璃纤维箱

TIP系列是新型的开关箱，它由玻璃纤维强化多元酯所制造，达到IP66、IK9等级。多元酯的特性是它本身混合30%玻璃纤维来强化，使它达到一个高电阻和机械刚度（IK9）与重量约1/3的金属箱的效果。同金属箱相比，TIP系列具有重量更轻，更适应腐蚀、潮湿的环境等优点

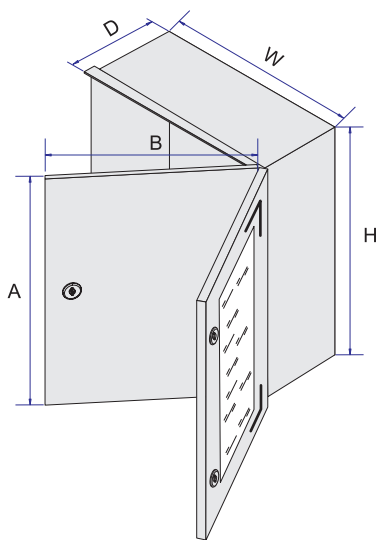

Model 型号	Dimension		
	Grey Door 灰色门	Transparent Door 透明门	W H D
TIP-325	TX-325	250×300×140	
TIP-430	TX-430	300×400×200	
TIP-440	TX-440	400×400×200	
TIP-540	TX-540	400×500×200	
TIP-640	TX-640	400×600×230	
TIP-650	TX-650	500×600×230	
TIP-860	TX-860	600×800×300	

Polyester Enclosure

玻璃纤维底板
Polyester plate

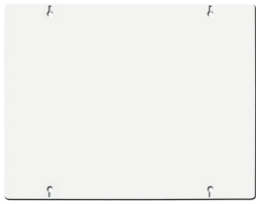

铁底板
Mounting plate

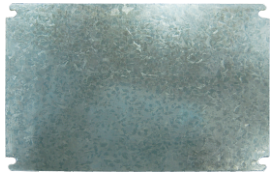

If the C greater than 500, the floor will be bent, the table below for after bending size.

宽度大于500以上的底板会被折弯。

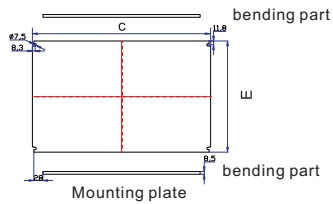
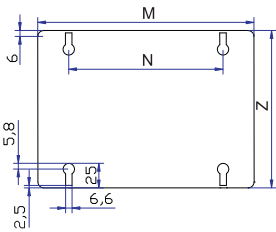

Polyester plate 玻璃纤维底板	Dimension			Mounting plate 铁底板	Dimension	
	M	N	Z		C	E
PP-325	220	238	157	TI-325	263	201
PP-43	310	285	210	TI-43	353	245
PP-44	307	385	227	TI-44	349	345
PP-54	408	385	277	TI-54	453	345
PP-64	510	358	327	TI-64	553	345
PP-65	507	485	327	TI-65	553	447
PP-86	705	580	477	TI-86	749	540

里门
Inner door

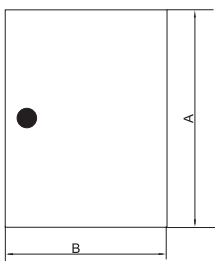

Inner door 里门	Dimension	
	A	B
TP-43	366	258
TP-44	366	358
TP-54	466	358
TP-64	566	358
TP-65	566	458
TP-86	766	658



FOR ALL TIP BOX

玻璃纤维箱的锁和挂墙钩

铸铝机箱

Aluminum Enclosure

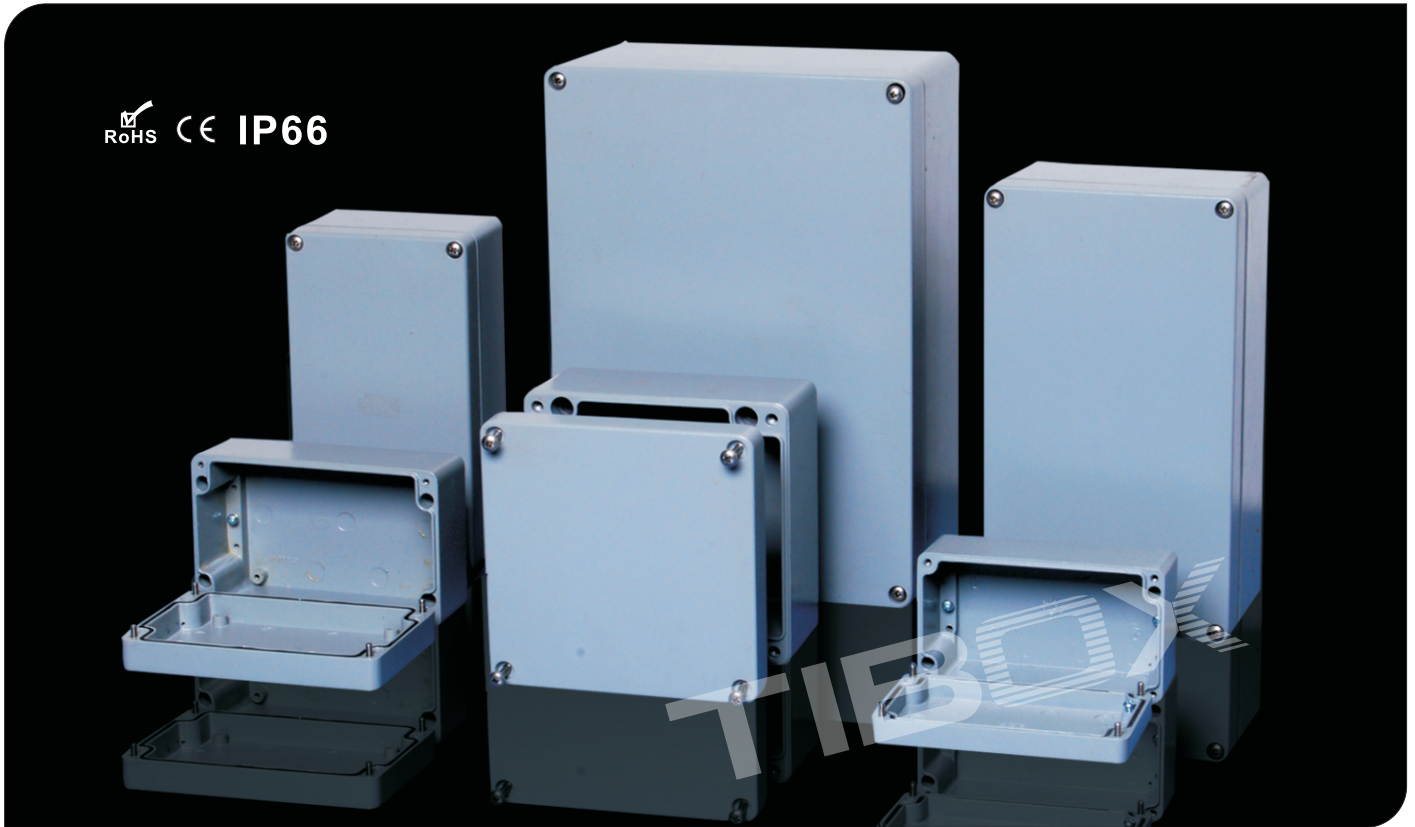

LV系列铸铝接线盒采用高质量压铸铝合金材料压铸而成。具有结构合理简洁、优秀的抗冲击性能、有效的密封性能和良好的抗电磁干扰的特点。

接线盒内可安装接线端子线路板或其他电气元件，适用于各种自动化领域。

LV Aluminium boxes are suitable for installation, circuit breaking, connection and control of electric and electronic equipments, and find their main application in industrial, automotive, railways, navy, tunnels, parkings, industrial buildings fields ensuring a high mechanical and vibration resistance with IP66 protection degree.

标准配置

箱体、箱盖、盖板、螺丝

工艺特点

- 1.材料：压铸铝合金Alsi12
- 2.密封条：硅橡胶（可提供特种密封条）
- 3.防护等级：IP66（可提供认证）
- 4.使用环境温度：-50℃至+130℃
- 5.盒盖螺钉：不锈钢十字槽（不易脱落）
- 6.颜色：银灰（可提供特殊颜色）

Standard Supply:

Aluminum box PUR Seal Stainless steel screws, M4 screws

Specification:

Material: AISI 12 DINI725 Standard

Protection Degree: IP66 EN60529 Standard

Resistance to Impact: >7 Joule EN50014 Standard

Temperature Range: -50℃ to 130℃

Paint Finish: Epoxy polyester powder coating

Color: RAL7038

Selection Table 选型表

MODEL	W H D
LV0605	64×58×36
LV1106	115×65×55
LV1106-1	110×65×37
LV0807	80×75×59
LV1208	120×80×55
LV1208-1	120×80×55
LV1308	135×85×57
LV1708	174×80×58
LV2508	250×80×65
LV2508-1	250×80×80
LV1409	148×98×43

MODEL	W H D
LV1610	160×100×60
LV1212	120×120×80
LV1812	188×120×80
LV1414	140×140×75
LV2214	220×146×60
LV2214-1	220×146×77
LV2214-2	220×147×80
LV2315	230×150×73
LV1616	160×160×90
LV1616-1	160×160×70
LV2416	240×160×75

MODEL	W H D
LV2416-1	240×160×100
LV1418	140×180×62
LV2618	265×185×95
LV2619	265×190×130
LV3021	300×210×130
LV2318	280×230×110
LV3423	340×230×95
LV3423-1	340×230×120
LV3423-2	340×230×135
LV3423-3	340×230×160
LV1925	190×250×92

Aluminum Enclosure

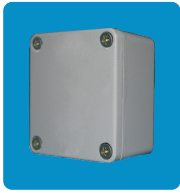

LV0605



LV1106

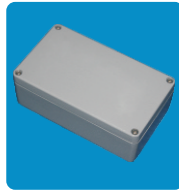

LV1106-1

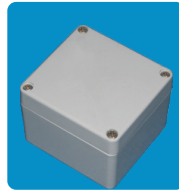

LV0807



LV1208



LV1208-1



LV1308

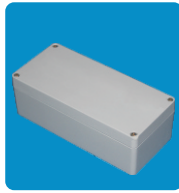

LV1708

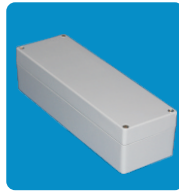

LV2508

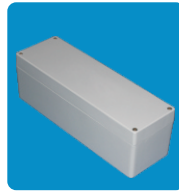

LV2508-1

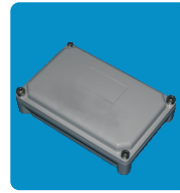

LV1409



LV1610

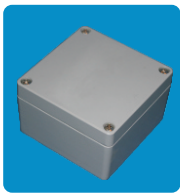

LV1212

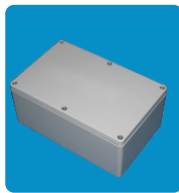

LV1812



LV1414



LV2214



LV2214-1

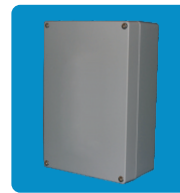

LV2214-2



LV2315

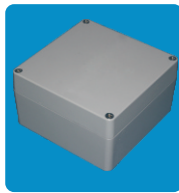

LV1616

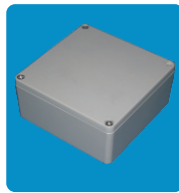

LV1616-1

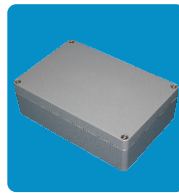

LV2416

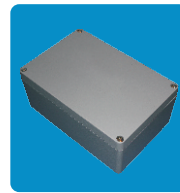

LV2416-1

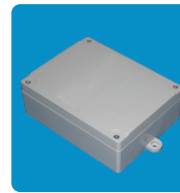

LV1418

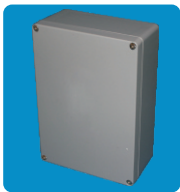

LV2618

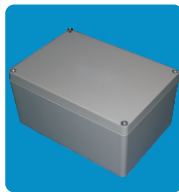

LV2619



LV3021



LV2828

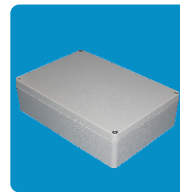

LV3423



LV3423-1



LV3423-2

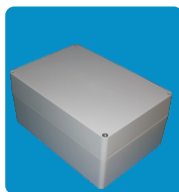

LV3423-3



LV1925

透气孔(呼吸器)

Air Vent Gland

AVG-M12 IP66

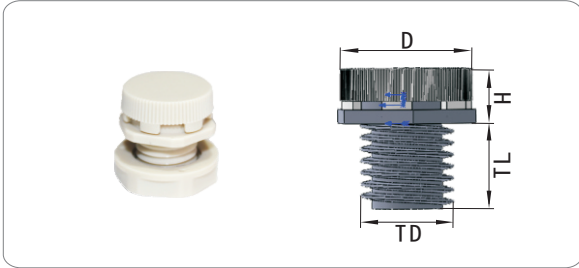

AVG-M16 IP66

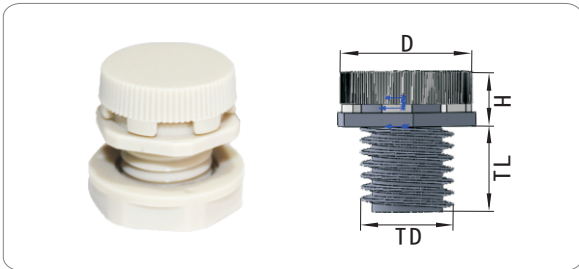

AVG-M20 IP66

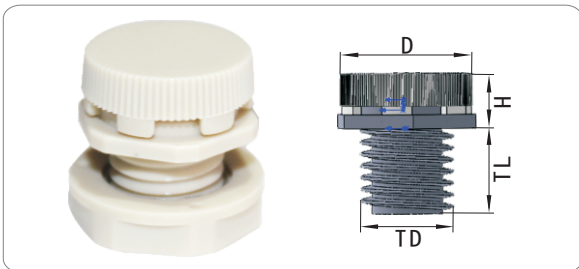

AVG-M40 IP66

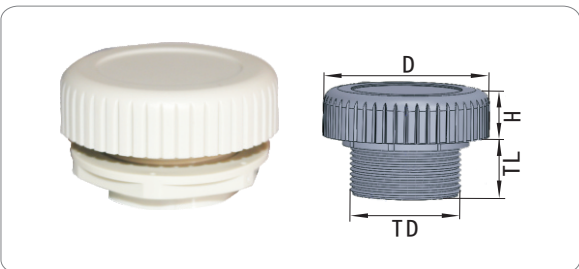

AVG-M40 IP55

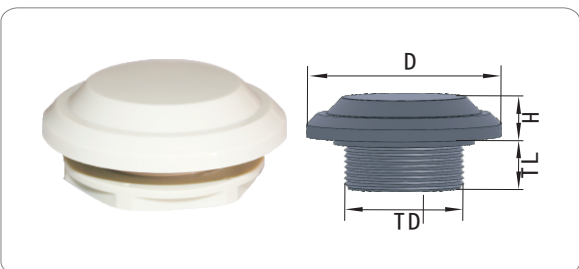

In order to choose the right ventilation plug unit (pressure balance elements) for a specific application, the working principles of the unit must be known first.

Ventilation plugs are permeable to "gases and vapours, e.g. air" but impermeable to "liquids and dust, e.g. water". The permeability resistance to liquids depends on the pore size and structure of the membrane inside these devices.

If the working conditions of water (the most common liquid) are studied, it is possible to say that the water intrusion pressure goes down as air permeability increases. The relevant specifications are collected in tabulated data.

Of the relevant parameters, the "Pressure Balance" function depends on the differential pressure between the inner and the outer environments of the enclosure. As a reference pressure, 70 mBar (70mBar = 1 Psi) value is chosen to present data. Under normal conditions, air circulation exists for all differential pressure levels. But the volume flow rate is very low for smaller values and obviously increases with increasing pressure values. Of course the air flow rate also depends on the properties of the membrane (classified as standard, medium, high and ultra high permeability types).

If there is no water pressure danger (if the device is not immersed in the water), it is always better to choose highly permeable elements for good circulation even for low differential pressure levels.

In essence, there is air circulation in the enclosure from the inside to the outside when the device is heating up due to its operation. Similarly, a circulation in reverse direction occurs during the cooling period. It should also be noted that there is always a level of humidity in air, hence some water in the form of vapour is also circulated with air. However condensed water is blocked by the water repellent membrane unless the differential pressure exceeds the intrusion pressure threshold.

After this technical overview, the utility of the "Ventilation Plugs" can be listed as follows:

- Prevention of pressure increase inside the enclosure. The pressure sensitive elements are not threatened.
- Limiting of temperature increase by the air circulation. The temperature sensitive elements are not threatened.
- Added flexibility for maintenance. In traditional units, when the enclosures are heated, generally the dilated air goes out from the seals but can not return back when the device is colder. Because of the vacuum formed inside the enclosure, the gaskets are exposed to large pressure levels. In result, it is very difficult to open the covers for maintenance. Especially in "luminaires" it is obligatory to change the bulbs when the device is cold. The ventilation plugs in our system prevent these kind of limitations.
- Prevention of accidental water suction into the system. During the cooling period, we know that there is air circulation from the outside to the inside. Hence, if the enclosure is wet from rain or due to other reasons, some water may be sucked inside the enclosure if there is no ventilation plug.
- Prevention of exposure to hot, humid, compressed gases. There is always a level of humidity in the enclosure due to atmospheric conditions. Hence when the device is hot, all the components will be exposed to a hot, humid and compressed environment without the ventilation plug.

To conclude, the ventilation plug can reduce and even fully eliminate the adverse effects of humidity in the environment. Water drops on the bottom of the enclosure are normal, but the inherent damage becomes insignificant due to the existence of a ventilation plug.

Air Vent Gland

压力平衡元素 PRESSURE BALANCE ELEMENTS

为了为特定的应用程序选择合适的通气塞装置（压力平衡元素），必须首先知道该单位的工作原理。

通气塞可渗透“气体和蒸气，比如：空气”，但不能渗透“液体和灰尘，比如：水”。这些装置的内膜的孔径大小和结构决定了液体渗透性阻力。

如果水（最常见的液体）的工作条件的研究，可以说，水入侵的压力下降，空气渗透率增大。相关规格的测试数据在表格中可以查到。

有关的参数，“压力平衡”功能取决于内、外壳的所处环境之间的不同压力。作为一个参考压力，70毫巴（70mBar=1 PSI）值的选择呈现的数据。在正常条件下，空气流通存在于所有不同的压力水平。但体积流率是非常低的较小的值，随着压力的增加值明显增加。当然，空气流动速度也取决于膜的性能（分类为标准，中，高和超高渗透型）。

如果没有水压力的危险（如果装置没有浸在水里），那么对于好坏不同程度的环境来说，高渗透性的良好循环始终是较好的选择

在本质上讲，由于这种操作当设备在加热时，伴随着装置外壳由内到外的空气流通。同样，在冷却期间会产生反向循环。还应指出的是，总会有一定湿度水平的空气中，水是以蒸汽的形式与空气流通着。除非压力差超过入侵的阈值压力，否则冷凝水会被防水性膜阻止。

对于该技术的概述后，那么“通气塞”的作用，可以列举如下：

1. 防止机箱内部的压力增加。压力敏感元件不受到威胁。
2. 通过空气流通，限制温度上升。温度敏感元件不受威胁。
3. 增加灵活性的维护。在传统的设备，当外壳被加热，一般扩张的空气从密封件不能返回装置，这样使得设备更冷。这是由于机箱内形成真空，垫片将会接触较大的压力。因此，为维护而打开盖子是非常困难的。特别是“灯具”，必须在装置是冷的时候更换灯泡。在我们的系统中，通气塞可以防止这类限制。

4. 预防突发性的水进入系统。我们也知道，在冷却期间空气流通是从外到内的。因此，如果没有通气塞，外壳因为下雨或其他原因而使变湿的话，那么一些水可能会进入机箱内。

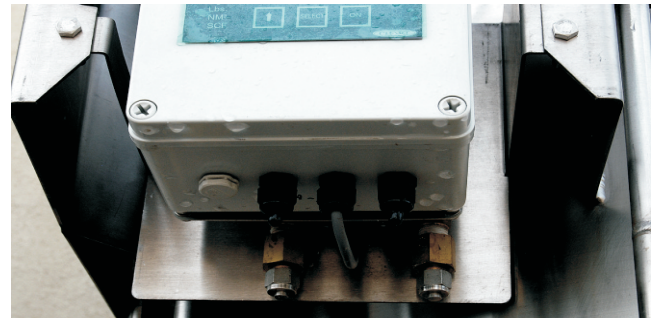

5. 防止接触高温，潮湿，压缩气体。由于大气条件总会使外壳出现一定程度的潮湿。因此，如果没有通气的话，当该装置是热的时候，那么所有的组件将直接接触高温，潮湿和压缩气体等环境。

总结来说，通气塞可以减少甚至完全消除湿度的环境中带来的不利影响。由于通气塞的存在，水滴在外壳底部是正常的，但内在损伤就变得微不足道。

Perm code 代码	Thread Size 螺纹的尺寸	Dimensions(mm) 尺寸				△P=1PSI=70m Bar Average Air permeability in lt/hour 每小时的平均空气渗透率				Water Intrusion pressure in Bar 水入侵压力				Plug Type 通气塞类型	Recom.Hole Diam.(mm) 推荐孔直径
		TD	TL	H	D	S	M	H	UH	S	M	H	UH		
According to the chosen air permeability One of the letters(S-M-H-UH) Have to be added before the code number	M12*1.5	12.0	10.0	10.0	24.0	42	120	450	750	0.9	0.5	0.2	0.1	F	12.5
	M16*1.5	16.0	10.0	11.0	24.0	42	120	450	750	0.9	0.5	0.2	0.1	F	16.5
	M20*1.5	20.0	10.0	11.5	24.0	42	120	450	750	0.9	0.5	0.2	0.1	F	20.5
	M40*1.5	40.0	18.0	18.0	60.0	120	375	1350	2200	0.9	0.5	0.2	0.1	G	40.5
	M40*1.5	40.0	14.0	12.5	60.0	120	375	1350	2200	0.9	0.5	0.2	0.1	G	40.5

通风过滤网罩 Air Filter Cover

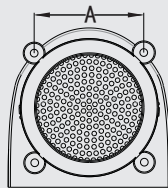
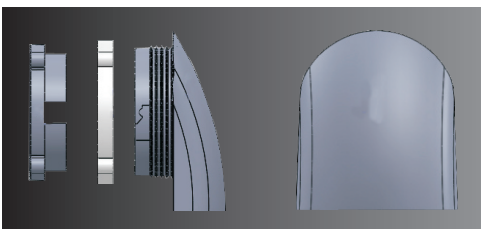

型号规格 Model And Size

Article No.	A	尺寸 Processing Size	排风盘尺寸 Ventilation Fan Size
BC-V 60	50 ± 0.3mm	63-65 φ	60 φ
BC-V 80	70 ± 0.3mm	88-90 φ	80 φ

产品特征 Product Characteristics

- 1、更有效地将盘内热空气带出
 - 2、更有效地将盘外冷空气带入
 - 3、特别的防雨盖设计，防止雨水侵入
- 1.It is easy to exhaust heat of inside box to outside.
2.It is easy to install cooling pan inside the box.
3.It is designed to prevent the penetration of rain.

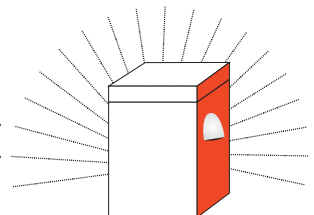

不锈钢机箱

Stainless Steel Wall Mount Enclosure

Stainless steel wall mount enclosure

Material: enclosure and door manufactured from AISI 304L sheet steel (AISI 316L on request)

Flat mounting plate manufactured from galvanised sheet steel. Hinges in stainless steel

Thickness of sheet steel: enclosure & door: sheet steel 1.2mm till size STX6 820, then 1.5mm

Thickness of mounting plate: zinc coated steel 1.5mm till size STX6 820 then 2.0mm

Supply include: enclosure body, door with lock & galvanised mounted plate, seal gasket and fixing accessories

Wall mount brackets 4pcs/set to be offered separately. Protection degree: IP 66 Impact resistance IK10



Stainless steel box with single blank door

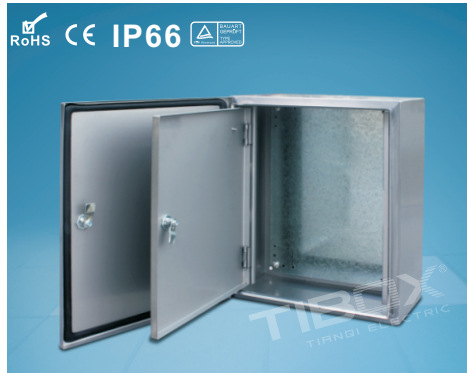

Stainless steel box with inner door - STXI

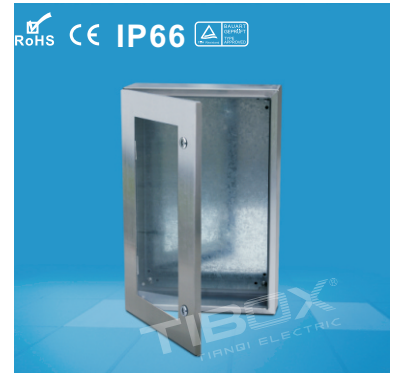

Stainless steel box with glazed door - STXP

Stainless steel box with inner door+ glazed door - STXIP

Model STX	Model STXI	Model STXP	Model STXIP	W × H × D(mm)
STX2 215	STXI2 215	STXP2 215	STXIP2 215	200×200×150
STX2 2515	STXI2 2515	STXP2 2515	STXIP2 2515	200×250×150
STX25 2515	STXI25 2515	STXP25 2515	STXIP25 2515	250×250×150
STX2 315	STXI2 315	STXP2 315	STXIP2 315	200×300×150
STX25 315	STXI25 315	STXP25 315	STXIP25 315	250×300×150
STX3 315	STXI3 315	STXP3 315	STXIP3 315	300×300×150
STX3 415	STXI3 415	STXP3 415	STXIP3 415	300×400×150
STX3 420	STXI3 420	STXP3 420	STXIP3 420	300×400×200
STX3 515	STXI3 515	STXP3 515	STXIP3 515	300×500×150
STX4 315	STXI4 315	STXP4 315	STXIP4 315	400×300×150
STX4 420	STXI4 420	STXP4 420	STXIP4 420	400×400×200
STX4 520	STXI4 520	STXP4 520	STXIP4 520	400×500×200
STX4 620	STXI4 620	STXP4 620	STXIP4 620	400×600×200
STX5 520	STXI5 520	STXP5 520	STXIP5 520	500×500×200
STX5 725	STXI5 725	STXP5 725	STXIP5 725	500×700×250
STX6 420	STXI6 420	STXP6 420	STXIP6 420	600×400×200

more size to be request to the clients...

Model STX	Model STXI	Model STXP	Model STXIP	W × H × D(mm)
STX6 620	STXI6 620	STXP6 620	STXIP6 620	600×600×200
STX6 625	STXI6 625	STXP6 625	STXIP6 625	600×600×250
STX6 630	STXI6 630	STXP6 630	STXIP6 630	600×600×300
STX6 820	STXI6 820	STXP6 820	STXIP6 820	600×800×200
STX6 1020	STXI6 1020	STXP6 1020	STXIP6 1020	600×1000×200
STX8 1020	STXI8 1020	STXP8 1020	STXIP8 1020	800×1000×200
STX6 825	STXI6 825	STXP6 825	STXIP6 825	600×800×250
STX6 1025	STXI6 1025	STXP6 1025	STXIP6 1025	600×1000×250
STX8 1225	STXI8 1225	STXP8 1225	STXIP8 1225	800×1200×250
STX6 830	STXI6 830	STXP6 830	STXIP6 830	600×800×300
STX6 1230	STXI6 1230	STXP6 1230	STXIP6 1230	600×1200×300
STX8 830	STXI8 830	STXP8 830	STXIP8 830	800×800×300
STX8 1030	STXI8 1030	STXP8 1030	STXIP8 1030	800×1000×300
STX8 1230	STXI8 1230	STXP8 1230	STXIP8 1230	800×1200×300
STX6 840	STXI6 840	STXP6 840	STXIP6 840	600×800×400
STX8 1440	STXI8 1440	STXP8 1440	STXIP8 1440	800×1400×400



Stainless steel terminal box

Stainless steel terminal box

Material: boxes and cover manufactured from thickness 1.2mm

AISI 304L (AISI316 on request)

Cover fixing with stainless steel screws.

Protection degree: IP 66

Impact resistance IK10

Supply include: enclosure & cover(sheet steel 1.2mm), sealing gasket and fixing accessories

Galvanised mounting plate to be offered separately

Wall mount brackets to be offered separately

Din-rail to be offered separately

Model	W × H × D(mm)
TLX15158	150×150×80
TLX151512	150×150×120
TLX201512	200×150×120
TLX20208	200×200×80
TLX30158	300×150×80
TLX301512	300×150×120

Model	W × H × D(mm)
TLX30208	300×200×80
TLX302012	300×200×120
TLX401512	400×150×120
TLX40208	400×200×80
TLX403012	400×300×120
TLX404012	400×400×120

Model	W × H × D(mm)
TLX502012	500×200×120
TLX503012	500×300×120
TLX602012	600×200×120
TLX603012	600×300×120
TLX802012	800×200×120
TLX804012	800×400×120

more size to be request to the clients...

Accessories For Stainless Steel Box

Lock for STX stainless steel enclosure



Wall mount brackets for STX stainless steel wall mount box

Model: WCX-010
Material: stainless steel AISI304
Package: 4pcs/set with fixing accessories

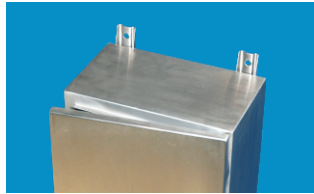

Wall mount brackets for TLX stainless steel terminal box

Model: WLX-010
Material: stainless steel AISI304
Package: 4pcs/set with fixing accessories



Canopy for STX stainless steel wall mount box

Model: TTX
Recommended for outdoor installation—Manufactured in 1.2mm AISI 304 stainless steel. Package: 1 piece

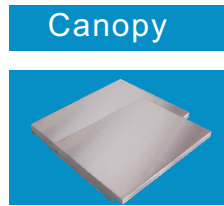

Model	For box size(mm)	
	W	D
TTX1 03	300	150
TTX2 03	300	200
TTX0 04	400	150
TTX1 04	400	200
TTX2 04	400	250
TTX3 04	400	300
TTX0 05	500	150
TTX1 05	500	200
TTX2 05	500	250

Model	For box size(mm)	
	W	D
TTX3 05	500	300
TTX0 06	600	200
TTX1 06	600	250
TTX2 06	600	300
TTX3 06	600	400
TTX0 08	800	200
TTX1 08	800	250
TTX2 08	800	300
TTX3 08	800	400

more size to be request to the clients...

Mounting plate for TLX stainless steel terminal box

Manufactured in 1.5mm galvanised sheet steel, for box MODEL TLX, TL, TB series
Package: 1 piece

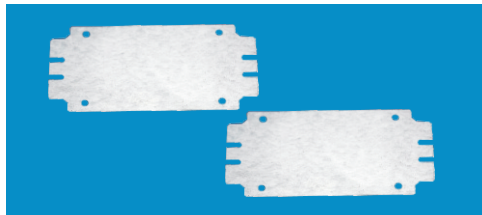

Model	For box size(mm)	
	W	H
TL1515	150	150
TL2015	200	150
TL2020	200	200
TL3015	300	150
TL3020	300	200
TL4015	400	150
TL4020	400	200

Model	For box size(mm)	
	W	H
TL4030	400	300
TL4040	400	400
TL5020	500	200
TL5030	500	300
TL6020	600	200
TL8020	800	200
TL8040	800	400

more size to be request to the clients...

Plinth for AR8X, AR9X stainless steel cabinet

Standard plinth: H=100mm, H=200mm PLX is made up of 1.5mm stainless steel

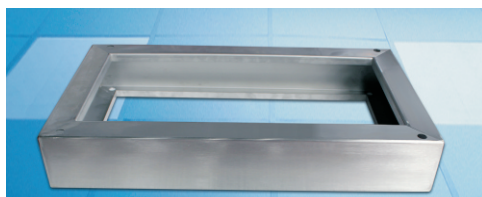

Stainless steel plinth PLX1, PLX2

Model	Cabinet size(mm)	Cabinet size(mm)	
		Width	Depth
H100	H200		
PLX1 35	PLX2 35	300	500
PLX1 36	PLX2 36	300	600
PLX1 38	PLX2 38	300	800
PLX1 45	PLX2 45	400	500
PLX1 46	PLX2 46	400	600
PLX1 64	PLX2 64	600	400
PLX1 65	PLX2 65	600	500
PLX1 66	PLX2 66	600	600

Model	Cabinet size(mm)	Cabinet size(mm)	
		Width	Depth
H100	H200		
PLX1 86	PLX2 86	800	600
PLX1 88	PLX2 88	800	800
PLX1 104	PLX2 104	1000	400
PLX1 105	PLX2 105	1000	500
PLX1 106	PLX2 106	1000	600
PLX1 108	PLX2 108	1000	800
PLX1 124	PLX2 124	1200	400
PLX1 125	PLX2 125	1200	500

more size to be request to the clients...

AR9X/AR9XP 不锈钢机柜

AR9X/AR9XP Stainless Steel Cabinet



Stainless steel cabinet AR9X type

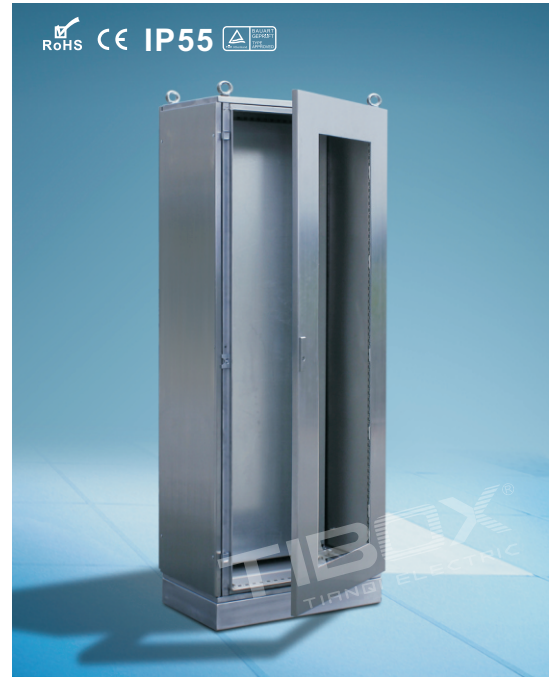

Stainless steel cabinet with glazed door AR9XP type

AR9X stainless steel cabinet

Material: stainless steel AISI304 or AISI316 (on request)
 Thickness: front door 2.0mm/ rear panel 1.5mm/ side panels 1.5mm/ top cover & bottom cable plate 1.5mm/ galvanised mounting plate 2.5mm/
 9-folded rails 1.5mm
 Protection ratings: IP 55
 Impact resistance IK10

Supply include:

9-folded rails 4pcs/set, door complete with MS821-X locking system and hinges , rear panel, side panels 2pcs/set, top cover, bottom with removable cable entry, 4 lifting eyebolts

AR9XP stainless steel cabinet with glazed door

Supply include:

9-folded rails 4pcs/set, door complete with MS821-X locking system with plexiglass window, and hinges , rear panel, side panels 2pcs/set, top cover, bottom with removable cable entry, 4 lifting eyebolts

Model	Model	W × H × D mm	NO. of door
AR9X 146/4	AR9XP 146/4	600 X 1400 X 400	1
AR9X 146/6	AR9XP 146/6	600 X 1400 X 600	1
AR9X 146/8	AR9XP 146/8	600 X 1400 X 800	1
AR9X 148/4	AR9XP 148/4	800 X 1400 X 400	1
AR9X 148/6	AR9XP 148/6	800 X 1400 X 600	1
AR9X 148/8	AR9XP 148/8	800 X 1400 X 800	1
AR9X 166/6	AR9XP 166/6	600 X 1600 X 600	1
AR9X 166/8	AR9XP 166/8	600 X 1600 X 800	1
AR9X 168/6	AR9XP 168/6	800 X 1600 X 600	1
AR9X 168/8	AR9XP 168/8	800 X 1600 X 800	1
AR9X 186/4	AR9XP 186/4	600 X 1800 X 400	1
AR9X 186/5	AR9XP 186/5	600 X 1800 X 500	1
AR9X 186/6	AR9XP 186/6	600 X 1800 X 600	1
AR9X 186/8	AR9XP 186/8	600 X 1800 X 800	1
AR9X 188/4	AR9XP 188/4	800 X 1800 X 400	1
AR9X 188/5	AR9XP 188/5	800 X 1800 X 500	1
AR9X 188/6	AR9XP 188/6	800 X 1800 X 600	1
AR9X 1810/4	AR9XP 1810/4	1000X 1800 X 400	1
AR9X 1810/5	AR9XP 1810/5	1000X 1800 X 500	1

Model	Model	W × H × D mm	No. of door
AR9X 203/8	AR9XP 203/8	300 X 2000 X 800	1
AR9X 204/5	AR9 XP 204/5	400 X 2000 X 500	1
AR9X 204/6	AR9XP 204/6	400 X 2000 X 600	1
AR9X 206/4	AR9XP 206/4	600 X 2000 X 400	1
AR9X 206/5	AR9XP 206/5	600 X 2000 X 500	1
AR9X 206/6	AR9XP 206/6	600 X 2000 X 600	1
AR9X 206/8	AR9XP 206/8	600 X 2000 X 800	1
AR9X 208/4	AR9XP 208/4	800 X 2000 X 400	1
AR9X 208/5	AR9XP 208/5	800 X 2000 X 500	1
AR9X 208/6	AR9XP 208/6	800 X 2000 X 600	1
AR9X 208/8	AR9XP 208/8	800 X 2000 X 800	1
AR9X 2010/4	AR9XP 2010/4	1000X 2000 X 400	1
AR9X 2010/5	AR9XP 2010/5	1000X 2000 X 500	1
AR9X 2010/6	AR9XP 2010/6	1000X 2000 X 600	1
AR9X 2010/8	AR9XP 2010/8	1000X 2000 X 800	1
AR9X 2012/4	AR9XP 2012/4	1200X 2000 X 400	1
AR9X 226/8	AR9XP 226/8	600 X 2200 X 800	1
AR9X 228/6	AR9XP 228/6	800 X 2200 X 600	1
AR9X 228/8	AR9XP 228/8	800 X 2200 X 800	1

Model	Model	W × H × D mm	NO. of door
AR9X 1810/4D	AR9XP 1810/4D	1000 X 1800X 400	2
AR9X 1810/5D	AR9XP 1810/5D	1000 X 1800X 500	2
AR9X 1810/6D	AR9XP 1810/6D	1000 X 1800X 600	2
AR9X 1812/4D	AR9XP 1812/4D	1200 X 1800X 400	2
AR9X 1812/5D	AR9XP 1812/5D	1200 X 1800X 500	2
AR9X 1812/6D	AR9XP 1812/6D	1200 X 1800X 600	2

Model	Model	W × H × D mm	NO. of door
AR9X 2010/8D	AR9XP 2010/8D	1000 X 2000X 800	2
AR9X 2012/4D	AR9XP 2012/4D	1200 X 2000X 400	2
AR9X 2012/5D	AR9XP 2012/5D	1200 X 2000X 500	2
AR9X 2012/6D	AR9XP 2012/6D	1200 X 2000X 600	2
AR9X 2012/8D	AR9XP 2012/8D	1200 X 2000X 800	2
AR9X 2210/6D	AR9XP 2210/6D	1000 X 2200X 600	2

more size to be request to the clients...

AR8X Stainless Steel Cabinet

AR8X one piece stainless steel cabinet

Material: stainless steel AISI304 or AISI316 (on request)

Protection ratings: IP 55

Impact resistance IK10

Thickness of the sheet steel:

Front door: 2.0mm/ rear panel 1.5mm / enclosure body 1.5mm/top cover & bottom cable plate 1.5mm/galvanised mounting plate: 2.5mm

Supply Include:

AR8X structure enclosure body, door complete with MS821-X locking system and hinges , rear panel, top cover, bottom with removable cable entry. 4 lifting eyebolts



Stainless steel cabinet AR8X+type

Model	W × H × D mm	no. of door
AR8X 1010/3D	1000 X 1000 X 300	2
AR8X 128/3	800 X 1200 X 300	1
AR8X 1210/3D	1000 X 1200 X 300	2
AR8 X1212/4D	1200 X 1200 X 400	2
AR8X 146/3	600 X 1400 X 300	1
AR8X 146/4	600 X 1400 X 400	1
AR8X 148/3	800 X 1400 X 300	1
AR8X 148/4	800 X 1400 X 400	1
AR8X 1410/4D	1000 X 1400 X 400	2
AR8X 1412/4D	1200 X 1400 X 400	2
AR8X 166/3	600 X 1600 X 300	1
AR8X 166/4	600 X 1600 X 400	1
AR8X 168/3	800 X 1600 X 300	1
AR8X 168/4	800 X 1600 X 400	1
AR8X 1610/3D	1000 X 1600 X 300	2
AR8X 1610/4D	1000 X 1600 X 400	2
AR8X 1612/3D	1200 X 1600 X 300	2
AR8X 1612/4D	1200 X 1600 X 400	2
AR8X 186/3	600 X 1800 X 300	1
AR8X 186/4	600 X 1800 X 400	1
AR8X 186/5	600 X 1800 X 500	1
AR8X 186/6	600 X 1800 X 600	1
AR8X 188/3	800 X 1800 X 300	1
AR8X 188/4	800 X 1800 X 400	1

Model	W × H × D mm	no. of door
AR8X 188/5	800 X 1800 X 500	1
AR8X 188/6	800 X 1800 X 600	1
AR8X 1810/4D	1000 X 1800 X 400	2
AR8X 1810/5D	1000 X 1800 X 500	2
AR8X 1812/4D	1200 X 1800 X 400	2
AR8X 1812/5D	1200 X 1800 X 500	2
AR8X 1816/4D	1600 X 1800 X 400	2
AR8X 1816/5D	1600 X 1800 X 500	2
AR8X 206/3	600 X 2000 X 300	1
AR8X 206/4	600 X 2000 X 400	1
AR8X 206/5	600 X 2000 X 500	1
AR8X 206/6	600 X 2000 X 600	1
AR8X 208/3	800 X 2000 X 300	1
AR8X 208/4	800 X 2000 X 400	1
AR8X 208/5	800 X 2000 X 500	1
AR8X 208/6	800 X 2000 X 600	1
AR8X 2010/4D	1000 X 2000 X 400	2
AR8X 2010/5D	1000 X 2000 X 500	2
AR8X 2012/4D	1200 X 2000 X 400	2
AR8X 2012/5D	1200 X 2000 X 500	2
AR8X 2012/6D	1200 X 2000 X 600	2
AR8X 2016/4D	1600 X 2000 X 400	2
AR8X 2016/5D	1600 X 2000 X 500	2
AR8X 2016/6D	1600 X 2000 X 600	2

more size to be request to the clients...

Transportation of AR8,AR9,AR8X,AR9X cabinet

(1) By forktruck

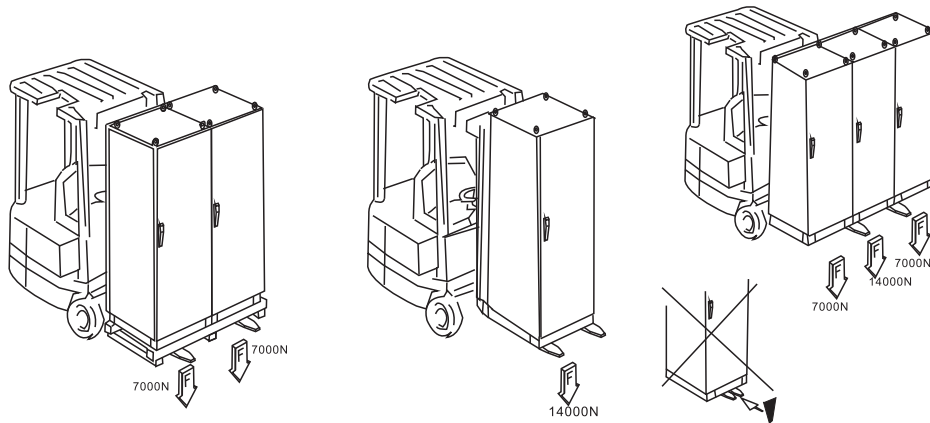

(3) Accessories

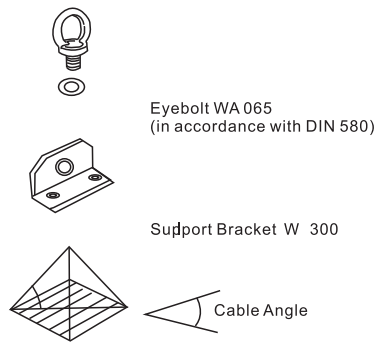

(2) By crane

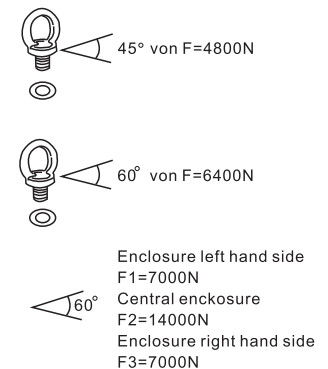
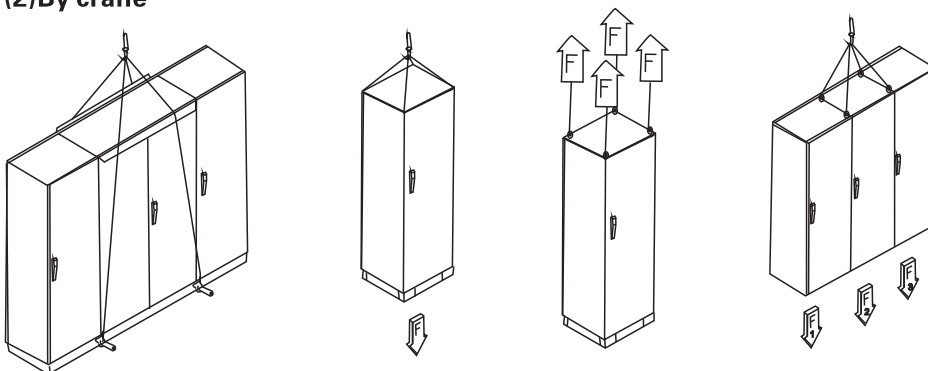

AR9000 单门/双门落地式机柜

AR9000 Floor Stand Cabinet (Single door/double door)



AR9000 floor stand cabinet

Supply Include

Front door with Reinforcing frame, hinges and MS821 lock system, 9 folded profiles 4pcs/set, rear panel, mounting plate & 4 mounting plate supports, 4 lifting eyebolts, top cover, removable cable gland plate

Standard Configuration

Paint finish epoxy polyester powder coating textured finish
 Color:RAL 7032 RAL 7035
 Profile:9-fold profile
 Material: cold rolling steel
 Thickness:front door:2.0mm,rear panel:1.5mm
 Mounting plate: zinc coated 2.5mm
 Protection degree:IP55
 Impact resistance: IK10

AR9000 floor stand cabinet

Single door AR9000 cabinet

Model	Dimension(mm)
	W × H × D
AR9 146/4	600 X1400 X 400
AR9 146/6	600 X1400 X 600
AR9 146/8	600 X1400 X 800
AR9 148/4	800 X1400 X 400
AR9 148/6	800 X1400 X 600
AR9 148/8	800 X1400 X 800
AR9 166/6	600 X1600 X 600
AR9 166/8	600 X1600 X 800
AR9 168/6	800 X1600 X 600
AR9 168/8	800 X1600 X 800
AR9 186/4	600 X1800 X 400
AR9 186/5	600 X1800 X 500
AR9 186/6	600 X1800 X 600
AR9 186/8	600 X1800 X 800
AR9 188/4	800 X1800 X 400
AR9 188/5	800 X1800 X 500
AR9 188/6	800 X1800 X 600
AR9 1810/4	1000X1800 X 400
AR9 1810/5	1000X1800 X 500
AR9 1810/6	1000X1800 X 600
AR9 203/5	300 X2000 X 500
AR9 203/6	300 X2000 X 600

Model	Dimension(mm)
	W × H × D
AR9 203/8	300 X 2000 X 800
AR9 204/5	400 X 2000 X 500
AR9 204/6	400 X 2000 X 600
AR9 206/4	600 X 2000 X 400
AR9 206/5	600 X 2000 X 500
AR9 206/6	600 X 2000 X 600
AR9 206/8	600 X 2000 X 800
AR9 208/4	800 X 2000 X 400
AR9 208/5	800 X 2000 X 500
AR9 208/6	800 X 2000 X 600
AR9 208/8	800 X 2000 X 800
AR9 2010/4	1000X 2000 X 400
AR9 2010/5	1000X 2000 X 500
AR9 2010/6	1000X 2000 X 600
AR9 2010/8	1000X 2000 X 800
AR9 2012/4	1200X 2000 X 400
AR9 226/8	600 X 2200 X 800
AR9 228/6	800 X 2200 X 600
AR9 228/8	800 X 2200 X 800
AR9 2210/6	1000X 2200 X 600
AR9 2210/8	1000X 2200 X 800

Double door AR9000 cabinet

Model	Dimension(mm)
	W × H × D
AR9 1810/4D	1000 X 1800X 400
AR9 1810/5D	1000 X 1800X 500
AR9 1810/6D	1000 X 1800X 600
AR9 1812/4D	1200 X 1800X 400
AR9 1812/5D	1200 X 1800X 500
AR9 1812/6D	1200 X 1800X 600
AR9 2010/4D	1000 X 2000X 400
AR9 2010/5D	1000 X 2000X 500
AR9 2010/6D	1000 X 2000X 600

Model	Dimension(mm)
	W × H × D
AR9 2010/8D	1000 X 2000X 800
AR9 2012/4D	1200 X 2000X 400
AR9 2012/5D	1200 X 2000X 500
AR9 2012/6D	1200 X 2000X 600
AR9 2012/8D	1200 X 2000X 800
AR9 2210/6D	1000 X 2200X 600
AR9 2210/8D	1000 X 2200X 800
AR9 2212/6D	1200 X 2200X 600
AR9 2212/8D	1200 X 2200X 800

more size to be request to the clients...

One Piece Floor Stand Cabinet

Plexiglass door / inner door for AR9000 cabinet



Plexiglass door ARPX model Inner door ARID model

Color: RAL 7032 or RAL 7035
 Protection degree: IP 55
 Material: Plexiglass 5.0mm
 Impact resistance: IK10

ARPX plexiglass door supply include:
 Plexiglass door thickness 5.0mm and fixing accessories
 lock system, hinges

ARID inner door supply include:
 inner door and fixing accessories, lock system, hinges

Plexiglass door / Inner door

Plexiglass door Model	Inner door Model	For box size(mm)	
		W	H
ARPX 126	ARID 126	600	1200
ARPX 128	ARID 128	800	1200
ARPX 146	ARID 146	600	1400
ARPX 148	ARID 148	800	1400
ARPX 166	ARID 166	600	1600
ARPX 168	ARID 168	800	1600
ARPX 186	ARID 186	600	1800
ARPX 188	ARID 188	800	1800
ARPX 1810	ARID 1810	1000	1800
ARPX 206	ARID 206	600	2000
ARPX 208	ARID 208	800	2000
ARPX 2010	ARID 2010	1000	2000
ARPX 226	ARID 226	600	2200
ARPX 228	ARID 228	800	2200

more size to be request to the client...

AR8000 one piece floor stand cabinet

Material: cold steel rolling sheet

Protection ratings: IP 55, Impact resistance IK10

Color: RAL7032 RAL7035, paint finish epoxy polyester powder coating textured finish

Thickness of the sheet steel: Front door: 2.0mm/ rear panel 1.5mm / enclosure body 1.5mm/top cover & bottom cable plate 1.5mm/
 galvanised mounting plate: 2.5mm

Supply Include:

AR8 structure enclosure body, door complete with MS821-X locking system and hinges , rear panel, top cover, bottom with removable cable entry, 4 lifting eyebolts



AR8000 one piece cabinet

AR8000 one piece cabinet-single door/double door

Model	W × H × D	NO. of door	Model	W × H × D	NO. of door
AR8 1010/3D	1000 X 1000 X 300	2	AR8 188/5	800 X 1800 X 500	1
AR8 128/3	800 X 1200 X 300	1	AR8 188/6	800 X 1800 X 600	1
AR8 1210/3D	1000 X 1200 X 300	2	AR8 1810/4D	1000 X 1800 X 400	2
AR8 1212/4D	1200 X 1200 X 400	2	AR8 1810/5D	1000 X 1800 X 500	2
AR8 146/3	600 X 1400 X 300	1	AR8 1812/4D	1200 X 1800 X 400	2
AR8 146/4	600 X 1400 X 400	1	AR8 1812/5D	1200 X 1800 X 500	2
AR8 148/3	800 X 1400 X 300	1	AR8 1816/4D	1600 X 1800 X 400	2
AR8 148/4	800 X 1400 X 400	1	AR8 1816/5D	1600 X 1800 X 500	2
AR8 1410/4D	1000 X 1400 X 400	2	AR8 206/3	600 X 2000 X 300	1
AR8 1412/4D	1200 X 1400 X 400	2	AR8 206/4	600 X 2000 X 400	1
AR8 166/3	600 X 1600 X 300	1	AR8 206/5	600 X 2000 X 500	1
AR8 166/4	600 X 1600 X 400	1	AR8 206/6	600 X 2000 X 600	1
AR8 168/3	800 X 1600 X 300	1	AR8 208/3	800 X 2000 X 300	1
AR8 168/4	800 X 1600 X 400	1	AR8 208/4	800 X 2000 X 400	1
AR8 1610/3D	1000 X 1600 X 300	2	AR8 208/5	800 X 2000 X 500	1
AR8 1610/4D	1000 X 1600 X 400	2	AR8 208/6	800 X 2000 X 600	1
AR8 1612/3D	1200 X 1600 X 300	2	AR8 2010/4D	1000 X 2000 X 400	2
AR8 1612/4D	1200 X 1600 X 400	2	AR8 2010/5D	1000 X 2000 X 500	2
AR8 186/3	600 X 1800 X 300	1	AR8 2012/4D	1200 X 2000 X 400	2
AR8 186/4	600 X 1800 X 400	1	AR8 2012/5D	1200 X 2000 X 500	2
AR8 186/5	600 X 1800 X 500	1	AR8 2012/6D	1200 X 2000 X 600	2
AR8 186/6	600 X 1800 X 600	1	AR8 2016/4D	1600 X 2000 X 400	2
AR8 188/3	800 X 1800 X 300	1	AR8 2016/5D	1600 X 2000 X 500	2
AR8 188/4	800 X 1800 X 400	1	AR8 2016/6D	1600 X 2000 X 600	2

more size to be request to the client...

AR9K 拆装式机柜

AR9000K Floor Stand Cabinet

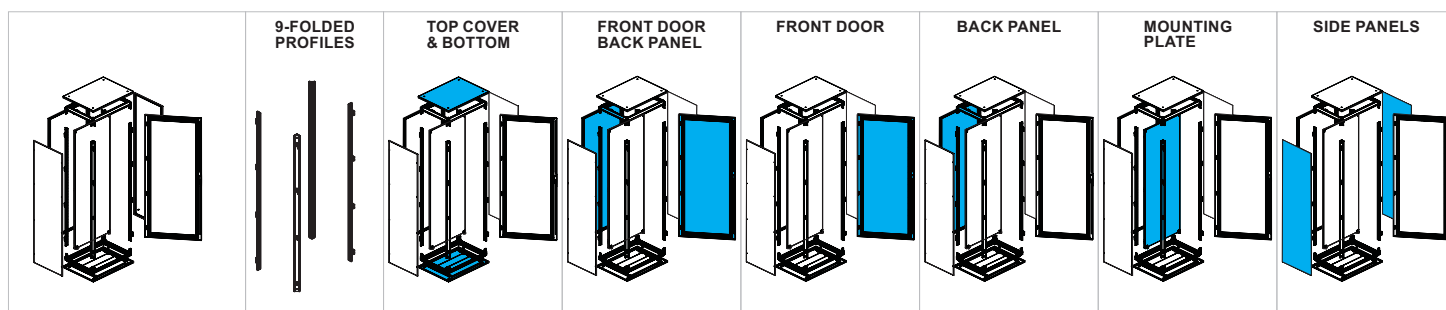

MODEL	SIZE(W H D) mm	9-FOLDED PROFILES	TOP COVER & BOTTOM	FRONT DOOR BACK PANEL	FRONT DOOR	BACK PANEL	MOUNTING PLATE	SIDE PANELS
AR9 164/4K	400X1600X400	F16	TCB44	FBD164	FD164	BD164	MP164	ARSP164
AR9 164/5K	400X1600X500	F16	TCB45	FBD164	FD164	BD164	MP164	ARSP165
AR9 164/6K	400X1600X600	F16	TCB46	FBD164	FD164	BD164	MP164	ARSP166
AR9 166/4K	600X1600X400	F16	TCB64	FBD166	FD166	BD166	MP166	ARSP164
AR9 166/5K	600X1600X500	F16	TCB65	FBD166	FD166	BD166	MP166	ARSP165
AR9 166/6K	600X1600X600	F16	TCB66	FBD166	FD166	BD166	MP166	ARSP166
AR9 168/4K	800X1600X400	F16	TCB84	FBD168	FD168	BD168	MP168	ARSP164
AR9 168/5K	800X1600X500	F16	TCB85	FBD168	FD168	BD168	MP168	ARSP165
AR9 168/6K	800X1600X600	F16	TCB86	FBD168	FD168	BD168	MP168	ARSP166
AR9 184/4K	400X1800X400	F18	TCB44	FBD184	FD184	BD184	MP184	ARSP184
AR9 184/5K	400X1800X500	F18	TCB45	FBD184	FD184	BD184	MP184	ARSP185
AR9 184/6K	400X1800X600	F18	TCB46	FBD184	FD184	BD184	MP184	ARSP186
AR9 186/4K	600X1800X400	F18	TCB64	FBD186	FD186	BD186	MP186	ARSP184
AR9 186/5K	600X1800X500	F18	TCB65	FBD186	FD186	BD186	MP186	ARSP185
AR9 186/6K	600X1800X600	F18	TCB66	FBD186	FD186	BD186	MP186	ARSP186
AR9 188/4K	800X1800X400	F18	TCB84	FBD188	FD188	BD188	MP188	ARSP184
AR9 188/5K	800X1800X500	F18	TCB85	FBD188	FD188	BD188	MP188	ARSP185
AR9 188/6K	800X1800X600	F18	TCB86	FBD188	FD188	BD188	MP188	ARSP186
AR9 188/8K	800X1800X800	F18	TCB88	FBD188	FD188	BD188	MP188	ARSP188
AR9 1810/4K	1000X1800X400	F18	TCB104	FBD1810	FD1810	BD1810	MP1810	ARSP184
AR9 1810/5K	1000X1800X500	F18	TCB105	FBD1810	FD1810	BD1810	MP1810	ARSP185
AR9 1810/6K	1000X1800X600	F18	TCB106	FBD1810	FD1810	BD1810	MP1810	ARSP186
AR9 204/4K	400X2000X400	F20	TCB44	FBD204	FD204	BD204	MP204	ARSP204
AR9 204/5K	400X2000X500	F20	TCB45	FBD204	FD204	BD204	MP204	ARSP205
AR9 204/6K	400X2000X600	F20	TCB46	FBD204	FD204	BD204	MP204	ARSP206
AR9 206/4K	600X2000X400	F20	TCB64	FBD206	FD206	BD206	MP206	ARSP204
AR9 206/5K	600X2000X500	F20	TCB65	FBD206	FD206	BD206	MP206	ARSP205
AR9 206/6K	600X2000X600	F20	TCB66	FBD206	FD206	BD206	MP206	ARSP206
AR9 206/8K	600X2000X800	F20	TCB68	FBD206	FD206	BD206	MP206	ARSP208
AR9 208/4K	800X2000X400	F20	TCB84	FBD208	FD208	BD208	MP208	ARSP204
AR9 208/5K	800X2000X500	F20	TCB85	FBD208	FD208	BD208	MP208	ARSP205
AR9 208/6K	800X2000X600	F20	TCB86	FBD208	FD208	BD208	MP208	ARSP206
AR9 208/8K	800X2000X800	F20	TCB88	FBD208	FD208	BD208	MP208	ARSP208
AR9 2010/4K	1000X2000X400	F20	TCB104	FBD2010	FD2010	BD2010	MP2010	ARSP204
AR9 2010/5K	1000X2000X500	F20	TCB105	FBD2010	FD2010	BD2010	MP2010	ARSP205
AR9 2010/6K	1000X2000X600	F20	TCB106	FBD2010	FD2010	BD2010	MP2010	ARSP206
AR9 226/4K	600X2200X400	F22	TCB64	FBD226	FD226	BD226	MP226	ARSP224
AR9 226/5K	600X2200X500	F22	TCB65	FBD226	FD226	BD226	MP226	ARSP225
AR9 226/6K	600X2200X600	F22	TCB66	FBD226	FD226	BD226	MP226	ARSP226
AR9 226/8K	600X2200X800	F22	TCB68	FBD226	FD226	BD226	MP226	ARSP228
AR9 228/4K	800X2200X400	F22	TCB84	FBD228	FD228	BD228	MP228	ARSP224
AR9 228/5K	800X2200X500	F22	TCB85	FBD228	FD228	BD228	MP228	ARSP225
AR9 228/6K	800X2200X600	F22	TCB86	FBD228	FD228	BD228	MP228	ARSP226
AR9 2210/4K	1000X2200X400	F22	TCB104	FBD2210	FD2210	BD2210	MP2210	ARSP224
AR9 2210/5K	1000X2200X500	F22	TCB105	FBD2210	FD2210	BD2210	MP2210	ARSP225
AR9 2210/6K	1000X2200X600	F22	TCB106	FBD2210	FD2210	BD2210	MP2210	ARSP226

AR9000K Floor Stand Cabinet

DOUBLE DOOR MODEL		9-FOLDED PROFILES	TOP COVER & BOTTOM	FRONT DOOR BACK PANEL	FRONT DOOR	BACK PANEL	MOUNTING PLATE	SIDE PANELS
AR9D 1610/4K	1000X1600X400	F16/D	TCB104/D	FBD1610/D	FD1610/D	BD1610	MP1610	ARSP164
AR9D 1610/5K	1000X1600X500	F16/D	TCB105/D	FBD1610/D	FD1610/D	BD1610	MP1610	ARSP165
AR9D 1612/4K	1200X1600X400	F16/D	TCB124/D	FBD1612/D	FD1612/D	BD1612	MP1612	ARSP164
AR9D 1612/5K	1200X1600X500	F16/D	TCB125/D	FBD1612/D	FD1612/D	BD1612	MP1612	ARSP165
AR9D 1810/4K	1000X1800X400	F18/D	TCB104/D	FBD1810/D	FD1810/D	BD1810	MP1810	ARSP184
AR9D 1810/5K	1000X1800X500	F18/D	TCB105/D	FBD1810/D	FD1810/D	BD1810	MP1810	ARSP185
AR9D 1810/6K	1000X1800X600	F18/D	TCB106/D	FBD1810/D	FD1810/D	BD1810	MP1810	ARSP186
AR9D 1812/4K	1200X1800X400	F18/D	TCB124/D	FBD1812/D	FD1812/D	BD1812	MP1812	ARSP184
AR9D 1812/5K	1200X1800X500	F18/D	TCB125/D	FBD1812/D	FD1812/D	BD1812	MP1812	ARSP185
AR9D 1812/6K	1200X1800X600	F18/D	TCB126/D	FBD1812/D	FD1812/D	BD1812	MP1812	ARSP186
AR9D 2010/4K	1000X2000X400	F20/D	TCB104/D	FBD2010/D	FD2010/D	BD2010	MP2010	ARSP204
AR9D 2010/5K	1000X2000X500	F20/D	TCB105/D	FBD2010/D	FD2010/D	BD2010	MP2010	ARSP205
AR9D 2010/6K	1000X2000X600	F20/D	TCB106/D	FBD2010/D	FD2010/D	BD2010	MP2010	ARSP206
AR9D 2012/4K	1200X2000X400	F20/D	TCB124/D	FBD2012/D	FD2012/D	BD2012	MP2012	ARSP204
AR9D 2012/5K	1200X2000X500	F20/D	TCB125/D	FBD2012/D	FD2012/D	BD2012	MP2012	ARSP205
AR9D 2012/6K	1200X2000X600	F20/D	TCB126/D	FBD2012/D	FD2012/D	BD2012	MP2012	ARSP206
AR9D 2210/5K	1000X2200X500	F22/D	TCB105/D	FBD2210/D	FD2210/D	BD2210	MP2210	ARSP225
AR9D 2210/6K	1000X2200X600	F22/D	TCB106/D	FBD2210/D	FD2210/D	BD2210	MP2210	ARSP226
AR9D 2212/5K	1200X2200X500	F22/D	TCB125/D	FBD2212/D	FD2212/D	BD2212	MP2212	ARSP225
AR9D 2212/6K	1200X2200X600	F22/D	TCB126/D	FBD2212/D	FD2212/D	BD2212	MP2212	ARSP226



AR9K metal floor stand cabinets comprise a 9-folded profile structure,un-welded at the top and bottom of the frame,with removable screws in vertical profiles for strength and versatility with the cabinets.Thermosetting epoxy polyester powder coating in textured RAL 7035 or RAL7032

Supply include

- 9-folded profiles 4pcs/set (model:F):hinged uprights, panel mounts and locking elements assembled.
- Top cover and base (Model: TCB):welded top frame , welded base,mounting plate fixing support.
- Back panel and front door (Model: FBD):plain door with lock, plain back panel.
- Galvanised mounting Plate(Model: MP)
- Side panels(Model: ARSP):2pcs side panels with accessories



TIBOX
TIANQI ELECTRIC



CE IP55



un-assembled type/knock-down type
Packed in 5 or 6 cartons(un-assembled type)
70% save in sea freight(un-assembled type)

TP/TPX 系列控制台

TP/TPX Series Control Desk



TP series control desk

Material: cold steel sheet

thickness of sheet steel

body: 1.5mm /front door:2.0mm /upper cover:2.0mm/galvanised mounting plate: 2.5mm

Color for the control desk: RAL7032 or RAL 7035

Supply include: control desk, front door with lock system, upper cover with cover stop 2pcs, 2 pcs gland cable plates, mounting plate

The accessories of plinth 100mm to be supplied separately according to the client's requirement

MODEL	W H D(D1)	NO.of doors	size of mounting plate(FXG)	Weight	Plinth 100mm
TP01	500 X 960 X 400(480) mm	1 door	430 X 780mm	38.8KGS	PL54-TP
TP02	600 X 960 X 400(480) mm	1 door	530 X 780mm	52KGS	PL64-TP
TP03	800 X 960 X 400(480) mm	1 door	730 X 780mm	65.2KGS	PL84-TP
TP04	1000 X 960 X 400(480) mm	2 doors	930 X 780mm	79.5KGS	PL104-TP
TP05	1200 X 960 X 400(480) mm	2 doors	1130 X 780mm	90.3KGS	PL124-TP

TPX series stainless steel control desk

Material: Stainless steel AISI304 or AISI 316

thickness of sheet steel

body: 1.5mm/front door:2.0mm/upper cover:2.0mm/galvanised mounting plate: 2.5mm

Supply include: control desk, front door with lock system, upper cover with cover stop 2pcs, 2 pcs gland cable plates, mounting plate

The accessories of plinth 100mm to be supplied separately according to the client's requirement

MODEL	W H D(D1)	NO.of doors	size of mounting plate(FXG)	Weight	Plinth 100mm
TPX01	500 X 960 X 400(480) mm	1 door	430 X 780mm	38.8KGS	PL54-TPX
TPX02	600 X 960 X 400(480) mm	1 door	530 X 780mm	52KGS	PL64-TPX
TPX03	800 X 960 X 400(480) mm	1 door	730 X 780mm	65.2KGS	PL84-TPX
TPX04	1000 X 960 X 400(480) mm	2 doors	930 X 780mm	79.5KGS	PL104-TPX
TPX05	1200 X 960 X 400(480) mm	2 doors	1130 X 780mm	90.3KGS	PL124-TPX

TP/TPX series control desk



ALP /AM series control desk

Material: cold steel sheet
 Thickness of sheet steel:
 Enclosure & door: 2.0mm sheet steel,galvanised mounting plate: 2.5mm
 Color: RAL7032 or RAL7035
 Finish: epoxy polyester powder coating textured finish
 protection degree: IP55
 Front/rear door and operation panel can be opened for convent installation.
 Zinc coated mounting plate can move back and forth.

ALP series control desk (include PE, LE, AE)

Supply include: part PE,part LE, part AE
 PE part :door with lock+hinges, mounting plate,enclosure body
 AE part: door with lock+hinges, mounting plate, enclosure body
 LE part: door with lock+hinges, door support 2pcs/set,enclosure body

AM series control desk (include ME, AE)

Supply include: part ME,part AE
 ME part :door with lock+hinges, door support 2pcs/set,enclosure body
 AE part: door with lock+hinges, mounting plate, enclosure body

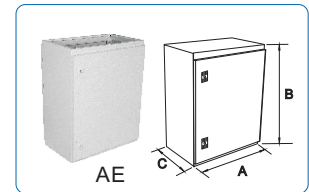
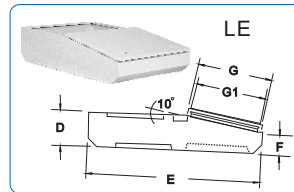
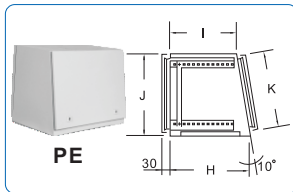

ALP control desk

ALP series control desk (include PE, LE, AE)

MODEL	PE				LE				AE		
	H	I	J	K	D	E	F	G	A	B	C
ALP41	370	295	460	425	200	835	120	425	600	770	400
ALP42	370	295	460	425	200	835	120	425	800	770	400
ALP43	370	295	460	425	200	835	120	425	1000	770	400
ALP44	370	295	460	425	200	835	120	425	1200	770	400
ALP45	370	295	460	425	200	835	120	425	1600	770	400
ALP51	440	365	460	425	200	935	120	425	600	770	500
ALP52	440	365	460	425	200	935	120	425	800	770	500
ALP53	440	365	460	425	200	935	120	425	1000	770	500
ALP54	440	365	460	425	200	935	120	425	1200	770	500
ALP55	440	365	460	425	200	935	120	425	1600	770	500

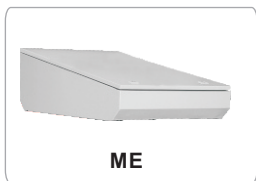

ME

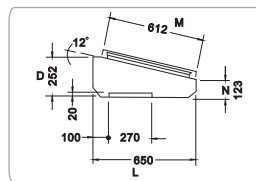

AE

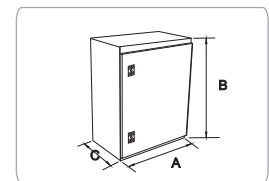

AM series control desk (include ME, AE)

MODEL	ME				AE		
	L	M	N	D	A	B	C
AM41	650	612	123	252	600	770	400
AM42	650	612	123	252	800	770	400
AM43	650	612	123	252	1000	770	400
AM44	650	612	123	252	1200	770	400
AM45	650	612	123	252	1600	770	400
AM51	750	712	123	275	600	770	500
AM52	750	712	123	275	800	770	500
AM53	750	712	123	275	1000	770	500
AM54	750	712	123	275	1200	770	500
AM55	750	712	123	275	1600	770	500



AM control desk

AR9/AR8 系列机柜附件

Accessories Of AR9/AR8 Floor Stand Cabinet



Multiple door

	Mode	Height(mm)	Mode	Height(mm)	
600mm	MT602	200	MTP602	195	
	MT603	300	MTP603	295	
	MT604	400	MTP604	395	
	MT605	500	MTP605	495	
	MT606	600	MTP606	595	
	MT608	800	MTP608	795	
	MT609	900	MTP609	895	
	MT6010	1000	MTP6010	995	
	800mm	MT802	200	MTP802	195
		MT803	300	MTP803	295
MT804		400	MTP804	395	
MT805		500	MTP805	495	
MT806		600	MTP806	595	
MT808		800	MTP808	795	
MT809		900	MTP809	895	
MT8010		1000	MTP8010	995	

In 2mm sheet steel complete with gasket and locking system, hinges MT: without plexiglass door
MTP: with plexiglass door

Clamp board

Model	Width(mm)	Pack
MT600	600	5PCS/SET
MT800	800	5PCS/SET

For multiple door is made up of 1.5mm, sheet steel with fixing accessories

Seal cover

Model	WXH(mm)	Pack
MT006	600x100	4
MT008	800x100	4

In 1.5mm sheet steel for sealing the top & bottom of cabinet, Supply include: 4pcs seal covers & its fixing accessories
Pack: 4pcs/set



Multiple door



Clamp board



Seal cover



Cabinet with blank front plate

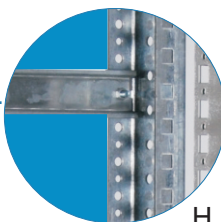
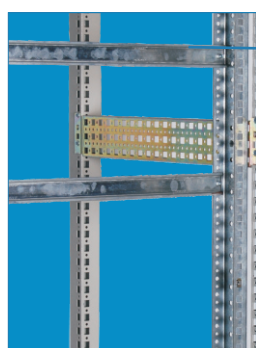

H rail



H rail for blank front plate

This rail is easy to fix on the cabinet height from 1400mm-2200mm, for fixing Din-rail C45, blank front panel (surface plate/flush plate)

H rail

Model	For cabinet height(mm)
H1400	1400mm
H1600	1600mm
H1800	1800mm
H2000	2000mm
H2200	2200mm

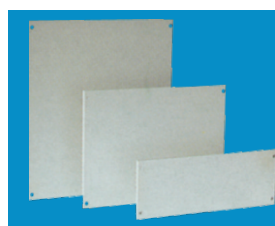

Surface plate



Flush plate

Blank front plate

Blank plate supplied with fixing accessories (screws with captice bush) pack: 1 piece

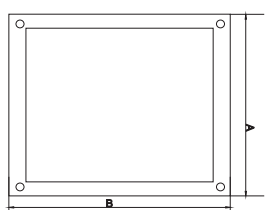
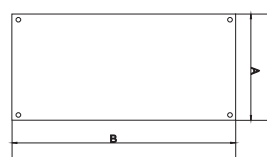

Surface plate

Model	cabinet width(mm)	Surface plate A	Surface plate B
MDP602	600	508	200
MDP603			300
MDP604			400
MDP606			600
MDP802	800	708	200
MDP803			300
MDP804			400
MDP806			600

Flush plate

Model	cabinet width(mm)	Panel(mm) A	Panel(mm) B
MDP604F	600	508	400
MDP606F			600
MDP804F	800	708	400
MDP806F			600

Accessories Of AR9000 Modular Cabinet

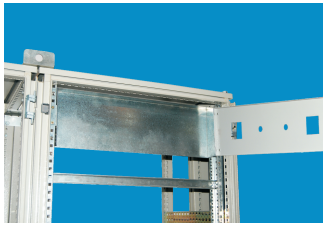

Punched front panels

COMPONENT PANEL
 Manufactured in 1.5mm sheet steel
 Supplied complete with DIN rail and fixing accessories(screws and captive bush)
 Supplied with panel,cover,rail,closed with captive screws provided
 Package:1 pc with accessories

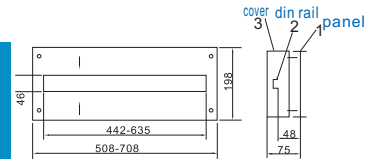
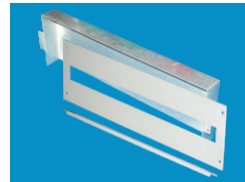
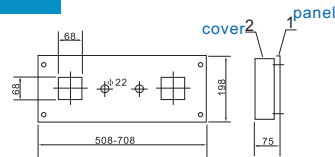
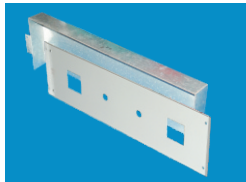

Panel for modular component

Flush panel

Cabinet Width	Ref	Description	Pcs	Model
600	1	PANEL	1	MDP03 102F
	2	COVER	1	MDP04 102
800	1	PANEL	1	MDP03 202F
	2	COVER	1	MDP04 202

Cabinet Width	Ref	Description	Pcs	Model
600	1	PANEL	1	MDP02 102F
	2	DIN RAIL 1×25P	1	
	3	COVER	1	
800	1	PANEL	1	MDP02 202F
	2	DIN RAIL 1×25P	1	
	3	COVER	1	



Panel for modular components

Manufactured in 1.5mm sheet steel.
 Supplied complete with zinc passivate DIN rail and fixing accessories with screws and captive bush.
 Package:singly

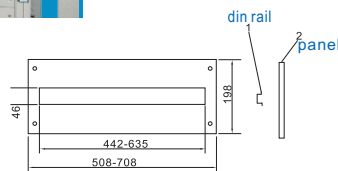

Flush panel

	Ref	Description	Pcs	Model
600	Panel 1x25P			MDP02 102F
	1	Din rail	1	
	2	Panel	1	
800	Panel 1x36P			MDP02 202F
	1	Din rail	1	
	2	Panel	1	

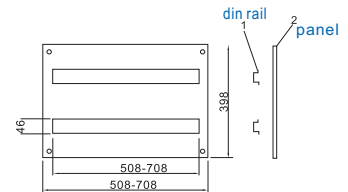
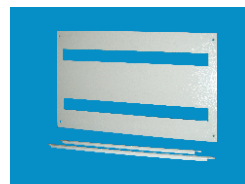

Flush panel

	Ref	Description	Pcs	Model
600	Panel 2x25P			MDP02 104F
	1	Din rail	1	
	2	Panel	1	
800	Panel 3x36P			MDP02 204F
	1	Din rail	1	
	2	Panel	1	

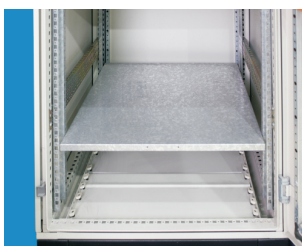

Component pallet

Two type:max carrying ability 50KG max carrying ability 100KG
 Material: manufactured in 1.5mm sheet steel with holes(except MPH604N&MPH605N&MPH606N)

Component pallet

Max.weight	W × D (mm)	50KG Model	50KG Model	100KG Model
600	300×471	MPH 604	MPH 604N	MPH 604F
	400×471	MPH 605	MPH 605N	MPH 605F
	500×471	MPH 606	MPH 606N	MPH 606F
	300×671	MPH 804	MPH 804N	MPH 804F
800	400×671	MPH 805	MPH 805N	MPH 805F
	500×671	MPH 806	MPH 806N	MPH 806F

HH rail for component pallet



Model	Height(mm)
HH1400	1400mm
HH1600	1600mm
HH1800	1800mm
HH2000	2000mm
HH2200	2200mm

落地式机柜附件

Stainless Steel Wall Mount Enclosure

WD rail, WW rail with mounting flange

Pack: 4pcs/set with 5 rows of universal skeletal structures of partial assembly.
Manufactured in 1.5mm zinc passivated sheet steel with 8pcs fixing screws M513mm

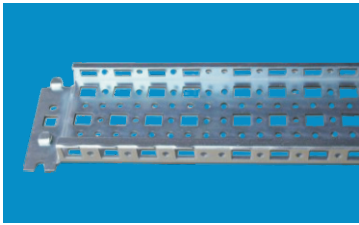

WD rail, WW rail with mounting flange

Model	For depth of cabinet(mm)			
	WD400	WD500	WD600	WD800
Dimension	400	500	600	800
Pcs/set	4	4	4	4
Model	WW600	WW800	WW1000	WW1200
	Dimension	600	800	1000
Pcs/set	4	4	4	4

Door rail

manufactured from 1.5mm sheet steel
pack: 1pcs door rail with fixing accessories

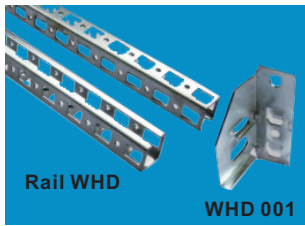

Perforated WHD rail

Rail 23x23mm model: WHD
Using angle bracket WHD001 install on the enclosure

Supply include:
1set(1pcs left bracket, 1pcs right bracket,
2pcs screws BZ5.5×13),angle bracket WHD001

Model	for cabinet width(mm)	Single or Double door
WA470	600	single
WA670	800	single
WA870	1000	single
WA270	800	double
WA370	1000	double

MODEL	WHD 400 (mm)	WHD 500 (mm)	WHD 600 (mm)	WHD 800 (mm)	WHD 1000 (mm)	WHD 1200 (mm)	WHD 1600 (mm)	WHD 1800 (mm)	WHD 2000 (mm)	WHD 2200 (mm)
LEGHT	295	395	495	695	895	1095	1495	1695	1895	2095
W H D	400	500	600	800	1000	1200	1600	1800	2000	2200
PCS/SET	12	12	12	12	12	12	6	6	6	6

UW rail

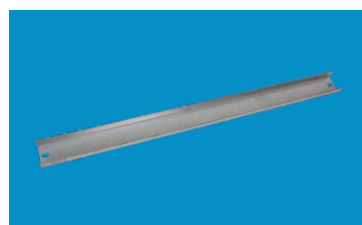
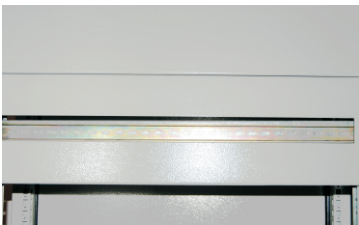

UW rail to be fixed on the cabinets width from 400mm-1200mm for replacement of mounting plate to hold electronic components
Material: galvanized steel sheet 2.5mm thickness
supply include: UW rails with fixing material

Model	For cabinet width(mm)	UW rail width (mm)
UW400	400	75
UW500	500	75
UW600	600	75
UW800	800	75
UW1000	1000	75
UW1200	1200	75

PC drawer(customized)

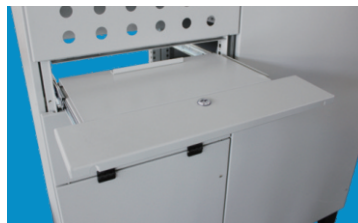

This is for special designed PC drawer, to be ordered to the clients special size

Computer pallet frame

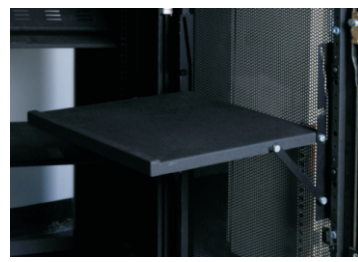

It is easy to turn down in maintaining and return between door frame after maintained.
Carrying capacity: 30KG largest

Model	W	D	Cabinet width (mm)
C44	413	400	600
C64	613	400	800

Stainless Steel Wall Mount Enclosure



Steel plan pocket

Color:RAL2008 thickness:1.5mm steel

For cabinet Width(mm)	Model	Size (mm)		
		W	H	D
400	PP400	255	260	90
500	PP500	355	260	90
600	PP600	455	260	90
800	PP800	655	260	90
900	PP900	755	260	90
1000	PP1000	855	260	90

A4 plastic plan pocket

Model:PP100 Material:ABS



Side cover

Material:sheet steel in 1.5mm

Color:RAL7032 or RAL7035

Supply :2pcs side covers & its fixing accessories

Function:connect into a complete cabinet

Model	Height (mm)	Depth (mm)
ARSP 124	1200	400
ARSP 126	1200	600
ARSP 128	1200	800
ARSP 144	1400	400
ARSP 146	1400	600
ARSP 148	1400	800
ARSP 166	1600	600
ARSP 168	1600	800
ARSP 184	1800	400

Model	Height (mm)	Depth (mm)
ARSP 185	1800	500
ARSP 186	1800	600
ARSP 188	1800	800
ARSP 204	2000	400
ARSP 205	2000	500
ARSP 206	2000	600
ARSP 208	2000	800
ARSP 226	2200	600
ARSP 228	2200	800

more size to be request to the clients...

AR8000/AR9000 plinth

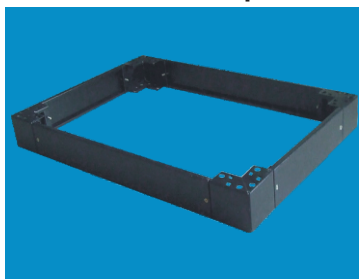

Standard plinth:H= 100mm, H=200mm
plinth is made up of 2.5mm cold steel roll sheet
paint finish epoxy polyester powder coating textured finish. Color:RAL6022

Model		Cabinet size(mm)	
H100	H200	Width	Depth
PL1 35	PL2 35	300	500
PL1 36	PL2 36	300	600
PL1 38	PL2 38	300	800
PL1 45	PL2 45	400	500
PL1 46	PL2 46	400	600
PL1 64	PL2 64	600	400
PL1 65	PL2 65	600	500
PL1 66	PL2 66	600	600

Model		Cabinet size(mm)	
H100	H200	Width	Depth
PL1 86	PL2 86	800	600
PL1 88	PL2 88	800	800
PL1 104	PL2 104	1000	400
PL1 105	PL2 105	1000	500
PL1 106	PL2 106	1000	600
PL1 108	PL2 108	1000	800
PL1 124	PL2 124	1200	400
PL1 125	PL2 125	1200	500

Sealing rubber strip

Model:RUB001 pack:10metro/roll
Width:15mm

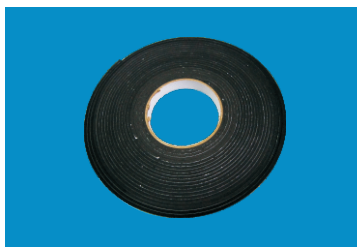

WA 065 ring



model: WA065
pack:4pcs/set

Special nut
model:SN-M6 or SN-M8
pack:50pcs/bag

Self tapping screw



Used for cabinet profiles,
punching rail and punching
material 4.5 mm round hole
Size:M5 X 10
Pack:100pcs/set

130° Hinge
model:TJ-CH130
pack:6pcs/set

Door stop

Model: DS001
Always keep the door open state
package:1 piece



Door stop

Model: WA100
For heavy equipment installation,
close the door when the door to
lift the ancilliary equipment
Package: 1 piece



Insert nut

Model: WA6 WA8
Special designed nut use to install
on AR9000 manufactured from zinc
Alloy.
Package:50pcs/set



落地式机柜附件



Fan and filter

ABS synthetic resin, fire resistant and UV-resistant, dustproof coefficient: 80%.

Fan

Model	The outer part	Voltage	Current	Air flow
KA1238HA2B	120×120×38mm	220~240VAC	0.13/0.11A	120/140CFM
KA1725HA2B	φ172×55mm	220~240VAC	0.13/0.12A	218/245CFM
KA2206HA2B-2P	φ220×60mm	220~240VAC	0.25/0.18A	430/490CFM
KA2509HA2B-2P	φ254×89mm	220~240VAC	0.28/0.22A	666/730CFM



Filter

Model	The outer part	Efficient blast volume	level of protection	Applicable blower fan
FU-9803A	148.5×148.5×13.5mm	25.0m3/min	IP44	KA1238HA2B
FU-9804A	204×204×13.5mm	50.0m3/min	IP44	KA1725HA2B
FU-9805A	255×255×13.5mm	80.0m3/min	IP44	KA2206HA2B-2P
FU-9806A	320×320×13.5mm	120m3/min	IP44	KA2509HA2B-2P

Divide plate

Divide plate is made up of 1.5mm sheet steel with fixing accessories, using HH rails, WD rails to hold divide plate



MODEL	cabinet width	W x H (mm)
MP 64	600	492X333
MP 82	800	692X133
MP 86	800	692X533
MP 104	1000	892X333
MP 106	1000	892X533
MP 122	1200	1092X133
MP 124	1200	1092X333
MP 126	1200	1092X533

WI300 ring

Model: WI300

4pcs/set with fixing accessories

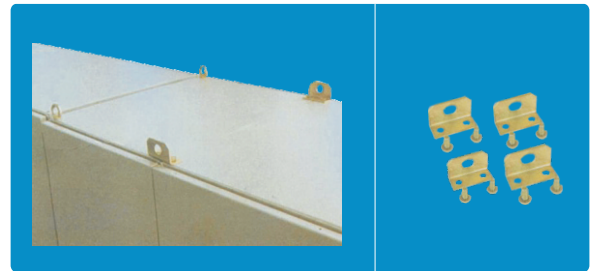

Baying bracket

Model: WA020

For connection and hanger two devices.

Material: sheet zinc-plating.

Package: 4pcs/set



Baying bracket

Model: WA030

For connection and hanger two devices.

Material: sheet zinc-plating

Package: 1pcs/set



Steel bolt anchor

Model: WA010

Hexagon steel proximate matter, supply include: its fixing accessories zinc-plating package: 6pcs/set



Lock MS 830

1pcs/set with lock system, key and fixing accessories



Lock MS 821

1pcs/set with lock system, key and fixing accessories



Innovation

Other special requested in size,technical processing,color and locking system can provide according to your requirement



Industrial Cabinets

perfect solution tailored just for you

挂墙式机箱

Wall Mount Enclosure



Single door wall mount enclosure

Supply Include:

Enclosure and door ,mounting plate, lock system, gland plate, sealing gasket and fixing accessories.

Standard Configuration

Paint finish epoxy polyester powder coating textured finish

Color: RAL 7032 or RAL 7035

Protection degree:IP 66

Against mechanical impacts: IK 10

Thickness:

Enclosure & door: sheet steel 1.2mm till size
ST6 820 then 1.5mm.

Mounting p late:

zinc-coated steel 1.5mm till size ST6 820 then 2.0mm

CONFORMITY AND APPROVAL



Mounting plate for wall mount enclosure

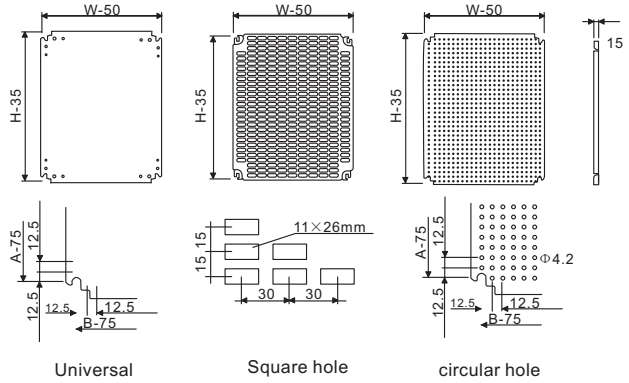

Note: door hinges on the left for the left open door,
door hinges on the right for the right open door

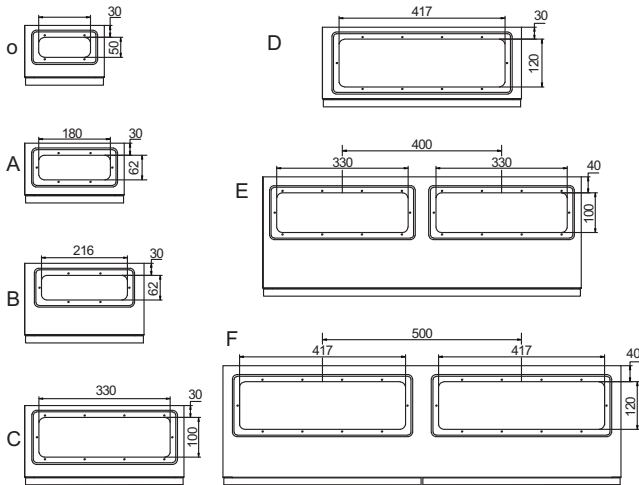

Selection Table

Model	W	H	D	No.of lock	Gland open
ST2 215	200	200	150	1	O
ST2 2515	200	250	150	1	O
ST25 2515	250	250	150	1	A
ST2 315	200	300	150	1	O
ST25 315	250	300	150	1	A
ST3 315	300	300	150	1	B
ST4 315	400	300	150	1	B
ST3 415	300	400	150	1	B
ST4 415	400	400	150	1	B
ST3 515	300	500	150	1	B
ST4 515	400	500	150	1	B
ST5 515	500	500	150	1	D
ST4 615	400	600	150	2	C
ST5 615	500	600	150	2	D
ST25 320	250	300	200	1	A
ST3 320	300	300	200	1	B
ST4 320	400	300	200	1	B
ST3 420	300	400	200	1	B
ST4 420	400	400	200	1	B
ST6 420	600	400	200	1	D
ST3 520	300	500	200	1	B
ST4 520	400	500	200	1	B

Model	W	H	D	No.of lock	Gland open
ST5 520	500	500	200	1	D
ST4 620	400	600	200	2	C
ST5 620	500	600	200	2	D
ST6 620	600	600	200	2	D
ST5 720	500	700	200	2	D
ST6 720	600	700	200	2	D
ST6 820	600	800	200	2	D
ST8 820	800	800	200	2	E
ST6 1020	600	1000	200	3	D
ST8 1020	800	1000	200	3	E
ST6 1220	600	1200	200	3	D
ST8 1220	800	1200	200	3	E
ST4 425	400	400	250	2	C
ST6 425	600	400	250	1	D
ST4 525	400	500	250	1	C
ST5 525	500	500	250	2	D
ST4 625	400	600	250	2	C
ST5 625	500	600	250	2	D
ST6 625	600	600	250	2	D
ST5 725	500	700	250	2	D
ST6 825	600	800	250	2	D
ST8 825	800	800	250	2	E

Model	W	H	D	No.of lock	Gland open
ST6 1025	600	1000	250	3	D
ST8 1025	800	1000	250	3	E
ST6 1225	600	1200	250	3	D
ST8 1225	800	1200	250	3	E
ST4 530	400	500	300	2	C
ST4 630	400	600	300	2	C
ST5 630	500	600	300	2	D
ST6 630	600	600	300	2	D
ST5 730	500	700	300	2	D
ST6 830	600	800	300	2	D
ST8 830	800	800	300	2	E
ST6 1030	600	1000	300	3	D
ST6 1230	600	1200	300	3	D
ST8 1030	800	1000	300	3	E
ST8 1230	800	1200	300	3	E
ST8 1430	800	1400	300	3	E
ST6 840	600	800	400	2	D
ST8 840	800	800	400	2	E
ST6 1040	600	1000	400	3	D
ST8 1040	800	1000	400	3	E
ST6 1240	600	1200	400	3	D
ST8 1240	800	1200	400	3	E
ST8 1440	800	1400	400	3	E

more size to be request to the clients...

Wall Mount Enclosure



Double door wall mount enclosure

Supply Include

Enclosure and door with lock system, galvanised mounting plate, gland plate, sealing gasket and fixing accessories.

Standard Configuration

Paint finish epoxy polyester powder coating textured finish

Color: RAL 7032 or RAL 7035

Protection degree: IP 55

Against mechanical impacts: IK 10

Thickness:

Enclosure & door: sheet steel 1.5mm.

Mounting plate:

Galvanised sheet steel :2.0mm

CONFORMITY AND APPROVAL



STD double door enclosure with standard lock K2

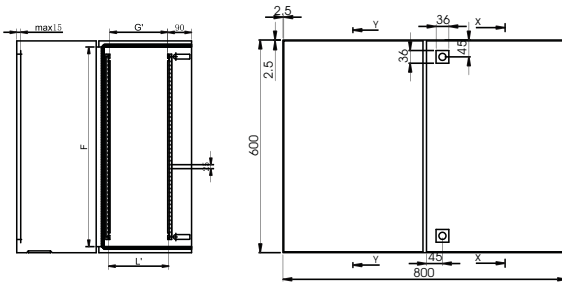

STDD(Rod Centre lock) with lock MS821

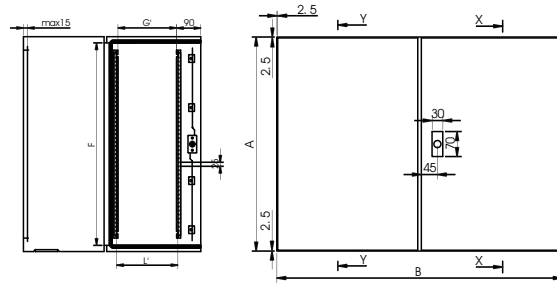

STD(standard lock K2)

Model	W	H	D	No.of lock	Gland open
STD8 620	800	600	200	2	E
STD8 625	800	600	250	2	E
STD8 630	800	600	300	2	E
STD8 640	800	600	400	2	E
STD10 620	1000	600	200	2	E
STD10 625	1000	600	250	2	E
STD10 630	1000	600	300	2	E
STD10 640	1000	600	400	2	E
STD12 620	1200	600	200	2	E
STD12 625	1200	600	250	2	E
STD12 630	1200	600	300	2	E
STD12 640	1200	600	400	2	E
STD8 820	800	800	200	2	F
STD8 825	800	800	250	2	F
STD8 830	800	800	300	2	F
STD8 840	800	800	400	2	F
STD10 820	1000	800	200	2	F
STD10 825	1000	800	250	2	F
STD10 830	1000	800	300	2	F
STD10 840	1000	800	400	2	F
STD12 820	1200	800	200	2	F
STD12 825	1200	800	250	2	F
STD12 830	1200	800	300	2	F
STD12 840	1200	800	400	2	F
STD10 1020	1000	1000	200	2	F
STD10 1025	1000	1000	250	2	F
STD10 1030	1000	1000	300	2	F
STD10 1040	1000	1000	400	2	F
STD12 1020	1200	1000	200	2	F
STD12 1025	1200	1000	250	2	F
STD12 1030	1200	1000	300	2	F
STD12 1040	1200	1000	400	2	F
STD10 1220	1000	1200	200	2	F
STD10 1225	1000	1200	250	2	F
STD10 1230	1000	1200	300	2	F
STD10 1240	1000	1200	400	2	F

STDD(Rod Centre lock) with lock MS821

Model	W	H	D	No.of lock	Gland open
STDD8 620	800	600	200	1	E
STDD8 625	800	600	250	1	E
STDD8 630	800	600	300	1	E
STDD8 640	800	600	400	1	E
STDD10 620	1000	600	200	1	E
STDD10 625	1000	600	250	1	E
STDD10 630	1000	600	300	1	E
STDD10 640	1000	600	400	1	E
STDD12 620	1200	600	200	1	E
STDD12 625	1200	600	250	1	E
STDD12 630	1200	600	300	1	E
STDD12 640	1200	600	400	1	E
STDD8 820	800	800	200	1	F
STDD8 825	800	800	250	1	F
STDD8 830	800	800	300	1	F
STDD8 840	800	800	400	1	F
STDD10 820	1000	800	200	1	F
STDD10 825	1000	800	250	1	F
STDD10 830	1000	800	300	1	F
STDD10 840	1000	800	400	1	F
STDD12 820	1200	800	200	1	F
STDD12 825	1200	800	250	1	F
STDD12 830	1200	800	300	1	F
STDD12 840	1200	800	400	1	F
STDD10 1020	1000	1000	200	1	F
STDD10 1025	1000	1000	250	1	F
STDD10 1030	1000	1000	300	1	F
STDD10 1040	1000	1000	400	1	F
STDD12 1020	1200	1000	200	1	F
STDD12 1025	1200	1000	250	1	F
STDD12 1030	1200	1000	300	1	F
STDD12 1040	1200	1000	400	1	F
STDD10 1220	1000	1200	200	1	F
STDD10 1225	1000	1200	250	1	F
STDD10 1230	1000	1200	300	1	F
STDD10 1240	1000	1200	400	1	F

more size to be request to the clients...

挂墙式机箱

Wall Mount Enclosure

Plexiglass door-inner door wall mount enclosure

Color: RAL 7032 or RAL 7035, paint finish epoxy polyester powder coating textured finish

Protection degree: IP 66

Against mechanical impacts: IK10

Enclosure & door & inner door: sheet steel 1.2mm till size ST6 820 then 1.5mm, mounting plate: zinc-coated steel 1.5mm till size ST6 820 then 2.0mm, plexiglass door 4.0mm



Plexiglass door wall mount enclosure (STP)

Supply include: enclosure, door with plexiglass & lock system, mounting plate, gland plate, sealing gasket and fixing accessories.



Inner door wall mount enclosure (STI)

Supply include: enclosure, door with lock system, inner door with lock systems, mounting plate, gland plate, sealing gasket and fixing accessories.



Plexiglass door + inner door wall mount enclosure (STIP)

Supply include: enclosure, outer door with plexiglass & lock system, inner door with lock systems, mounting plate, gland plate, sealing gasket and fixing accessories.

Model	Model	Model	W × H × D(mm)	No. of lock
STP2 315	STI2 315	STIP2 315	200×300×150	1
STP3 415	STI3 415	STIP3 415	300×400×150	1
STP3 420	STI3 420	STIP3 420	300×400×200	1
STP4 315	STI4 315	STIP4 315	400×300×150	1
STP4 420	STI4 420	STIP4 420	400×400×200	1
STP4 520	STI4 520	STIP4 520	400×500×200	1
STP4 620	STI4 620	STIP4 620	400×600×200	2
STP5 520	STI5 520	STIP5 520	500×500×200	1
STP5 725	STI5 725	STIP5 725	500×700×250	2
STP6 420	STI6 420	STIP6 420	600×400×200	2

Model	Model	Model	W × H × D(mm)	No. of lock
STP6 620	STI6 620	STIP6 620	600×600×200	2
STP6 625	STI6 625	STIP6 625	600×600×250	2
STP6 630	STI6 630	STIP6 630	600×600×300	2
STP6 820	STI6 820	STIP6 820	600×800×200	2
STP6 825	STI6 825	STIP6 825	600×800×250	2
STP6 830	STI6 830	STIP6 830	600×800×300	2
STP6 1230	STI6 1230	STIP6 1230	600×1200×300	3
STP8 830	STI8 830	STIP8 830	800×800×300	3
STP8 1030	STI8 1030	STIP8 1030	800×1000×300	3
STP8 1230	STI8 1230	STIP8 1230	800×1200×300	3

more size to be request to the client...

Modular kit for steel wall mount box



MODEL	DOOR (mm)		No. of breakers	Breakers qty PCS(mm)	No. of rows (mm)
	W	H			
MDST43	300	400	2rows×9P	18	2
MDST54	400	500	3rows×15P	45	3
MDST64	400	600	3rows×15P	45	3
MDST66	600	600	3rows×26P	78	3
MDST75	500	700	3rows×21P	60	4
MDST75R	500	700	4rows×21P	80	4
MDST86	600	800	3rows×26P	78	4
MDST86R	600	800	4rows×26P	104	4
MDST106	600	1000	6rows×26P	158	6
MDST108	800	1000	6rows×38P	222	6

more size to be request to the client...

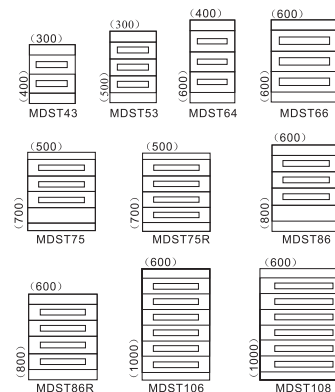

MCB Box/Gland Box/Telephone Box

MCB box

AS & AE series boxes are TIBOX specially designs for MCBs. This kind of surface & flush mounting boxes can assemble 16P & 24P MCBs each row, or adjust by your own. Material: Sheet steel 1.2mm
 Protection degree: IP54
 Surface finish: epoxy polyester powder coating textured finish
 Color: RAL 7035

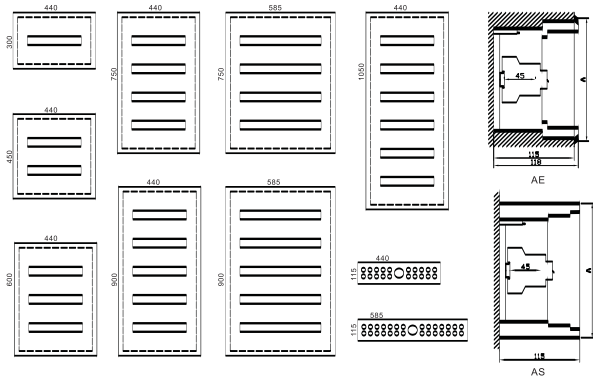

MCB box

Surface type	DOOR(mm)		1 ROW	NO. of breakers
	W	H		
AS1 16	440	300	1	× 16P
AS2 16	440	450	2	× 16P
AS3 16	440	600	3	× 16P
AS4 16	440	750	4	× 16P
AS5 16	440	900	5	× 16P
AS6 16	440	1050	6	× 16P
AS7 16	585	750	4	× 24P
AS8 16	585	900	5	× 24P

Flush type	DOOR(mm)		1 ROW	NO. of breakers
	W	H		
AE116	465	325	1	× 16P
AE216	465	475	2	× 16P
AE316	465	625	3	× 16P
AE416	465	775	4	× 16P
AE516	465	925	5	× 16P
AE616	465	1075	6	× 16P
AE716	610	775	4	× 24P
AE816	610	925	5	× 24P



Telephone enclosure

Telephone enclosure

TE enclosure are designed to standard telephone connectors used for domestic and commercial applicateion. Flush or surface mounting confirming to IP41. Madeout of high quality steel sheet, knock-outs provided on all sides adjustable zincmouning plate, with cam key lock Color: RAL 7035

Descripton	W(mm)	H(mm)	D(mm)	CONNECTION PAIRS	Cat.no
Surface Type	230	230	100	10 TO 40	TE2323
Flush type	230	230	100	10 TO 60	TEF2323
Surface Type	330	300	100	10 TO 70	TE3033
Flush type	330	300	100	10 TO 80	ETF3033
Surface Type	520	370	100	10 TO 140	TE3752
Flush type	520	370	100	10 TO 160	TEF3752
Surface Type	620	520	100	10 TO 420	TE5262



Gland box

Gland box

GB series box can be used as the gland box of the ST wall mount enclosure, Material: sheet steel 1.2mm ,surface finish: epoxy polyester powder coating textured finish Color:RAL7035 or RAL 7032

Model	Size(mm)		
	W	H	D
GB432	300	400	200
GB532	300	500	200
GB632	300	600	200
GB8325	300	800	250
GB4252	250	400	200
GB5252	250	500	200
GB6252	250	600	200
GB82525	250	800	250
GB422	200	400	200
GB522	200	500	200
GB1033	300	1000	300

接线盒系列

Steel Terminal Box

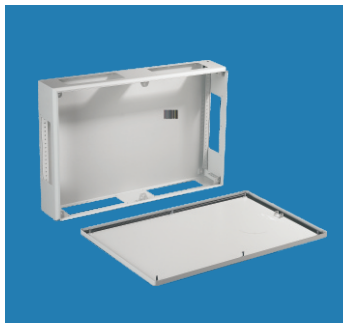

TL-G series - with gland hole

Supply Include: Enclosure & cover (sheet steel 1.2mm), sealing gasket and fixing accessories, Gland holes & gland plates
 Paint finish: epoxy polyester powder coating textured finish Color: RAL7032 or RAL7035
 Protection degree: IP66 Against mechanical impacts: IK10
 galvanised mounting plate to be supplied separately, see Page 09...

Model	W H D
TL301512-G	300×150×120
TL302012-G	300×200×120
TL303012-G	300×300×120
TL402012-G	400×200×120
TL404012-G	400×400×120
TL502012-G	500×200×120

Model	W H D
TL503012-G	500×300×120
TL602012-G	600×200×120
TL603012-G	600×300×120
TL604012-G	600×400×120
TL802012-G	800×200×120
TL804012-G	800×400×120

[more size to be request to the clients...](#)



TL series - No gland hole

Supply Include: Enclosure & cover (sheet steel 1.2mm), sealing gasket and fixing accessories,
 Paint finish: epoxy polyester powder coating textured finish Color: RAL7032 or RAL7035
 Protection degree: IP66 Against mechanical impacts: IK10
 galvanised mounting plate to be supplied separately, see Page 09...

Model	W H D
TL15158	150×150×80
TL151512	150×150×120
TL201512	200×150×120
TL20208	200×200×80
TL30158	300×150×80
TL301512	300×150×120

Model	W H D
TL30208	300×200×80
TL302012	300×200×120
TL401512	400×150×120
TL40208	400×200×80
TL403012	400×300×120
TL404012	400×400×120

Model	W H D
TL502012	500×200×120
TL503012	500×300×120
TL602012	600×200×120
TL603012	600×300×120
TL802012	800×200×120
TL804012	800×400×120

[more size to be request to the clients...](#)



TB series 180° hinges with lock system

Supply Include: Enclosure with gland holes, cover with sealing gasket and fixing accessories, lock system
 Paint finish: epoxy polyester powder coating textured finish.
 Color: RAL7032 or RAL7035 Protection degree: IP66 Against mechanical impacts: IK10
 galvanised mounting plate to be supplied separately, see Page 09...

Model	W H D
TB15158	150×150×80
TB15308	150×300×80
TB20208	200×200×80
TB20308	200×300×80
TB20408	200×400×80
TB151512	150×150×120
TB153012	150×300×120
TB202012	200×200×120

Model	W H D
TB203012	200×300×120
TB204012	200×400×120
TB205012	200×500×120
TB303012	300×300×120
TB304012	300×400×120
TB3040155	300×400×155
TB3060155	300×600×155
TB3080155	300×800×155

[more size to be request to the clients...](#)



TBS series 180° hinges with hinges

Supply Include: Enclosure with gland holes, cover with sealing gasket and fixing accessories
 Paint finish: epoxy polyester powder coating textured finish. Color: RAL7032 or RAL7035
 Protection degree: IP66 Against mechanical impacts: IK10
 galvanised mounting plate to be supplied separately, see Page 09...

Model	W H D
TBS15158	150×150×80
TBS15308	150×300×80
TBS20208	200×200×80
TBS20308	200×300×80
TBS20408	200×400×80

Model	W H D
TBS151512	150×150×120
TBS153012	150×300×120
TBS202012	200×200×120
TBS203012	200×300×120
TBS204012	200×400×120

Model	W H D
TBS205012	200×500×120
TBS303012	300×300×120
TBS304012	300×400×120
TBS3040155	300×400×155
TBS3060155	300×600×155

[more size to be request to the clients...](#)

Accessories Of Wall Mount Enclosure

Metal lock



LK-5



Lock transformations to zinc alloy insert triangle and square options

Rain-proof cover for lock



TK-5-A

WP001

Locks



K1



K2



K3



MS820



MS407



K4



LS-1



MS738

100mm high plinth can be used for ST boxes.
Material: sheet steel Color: RAL 6022

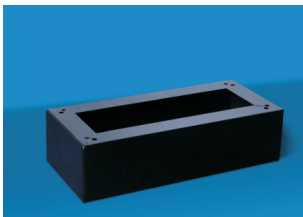

Plinth



Plinth for wall mount enclosure

Model	Cabinet size(mm)		Model	Cabinet size(mm)	
	W	D		W	D
TT42	400	200	TT43	400	300
TT52	500	200	TT53	500	300
TT62	600	200	TT63	600	300
TT82	800	200	TT83	800	300
TT102	1000	200	TT103	1000	300
TT122	1200	200	TT123	1200	300



Earth wire

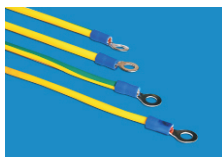

Earth wire for enclosure

Model	S(mm ²)	Length(mm)	Diameter of rings(mm)
TJ-CM6130	6	130	6.4
TJ-CM6160	6	160	6.4
TJ-CM6168	6	160	8.3
TJ-CM1025	10	250	6.4
TJ-CM2535	25	350	8.3



Plastic cover for MCB box

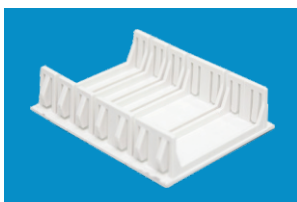

Model: MC09
MC18

molded plastic cover to be used in MCB enclosure to cover the holes, to avoid dust and water inside the MCB enclosure

MC09 9mm long 1/2P

MC18 18mm long 1P

挂墙式机箱附件

Accessories Of Wall Mount Enclosure



Canopy

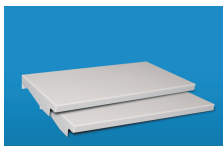

more size to be request to the clients...

Canopy (roof)

Model	For box size(mm)	
	W	D
TT1 03	300	150
TT2 03	300	200
TT0 04	400	150
TT1 04	400	200
TT2 04	400	250
TT3 04	400	300
TT0 05	500	150
TT1 05	500	200
TT2 05	500	250

Model	For box size(mm)	
	W	D
TT3 05	500	300
TT0 06	600	200
TT1 06	600	250
TT2 06	600	300
TT3 06	600	400
TT0 08	800	200
TT1 08	800	250
TT2 08	800	300
TT3 08	800	400

Recommended for outdoor installation.-Manufactured in 1.2mm sheet steel.

Surface finish: TIBOX standard cycle thermosetting epoxy polyester powder coating in textured for outdoor installation. we suggest a specific painting Color: RAL 7032 or RAL 7035



Door rail

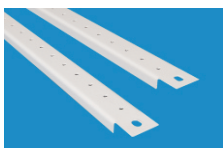

Door rail (crosspiece for door)

Mod.	Code		Width(mm) Box
	Art		
WC	001		300
WC	002		400
WC	003		500
WC	004		600
WC	005		800

To be fixed on the vertical rail of the door to simplify fixing of cable ducts. Manufactured in 1.2mm sheet steel. Zinc plated passivated with 4.2mmdiameter holes punched in 25mm pinch patten.Pack: 1piece with fixing material



WA 060



Door stop

Holds the door at 90° to avoid accidental closing. Manufactured in 2mm and 3mm sheet steel zinc plated passivated can be used on ST boxes till size ST6 820.

Pack of 1 piece with fixing material

Model: WA 060



WA 070



Door stop

Holds the door at 90° to avoid accidental closing. Manufactured in 2mm and 3mm sheet steel zinc plated passivated can be used on ST boxes from ST6 820

Pack of 1 piece with fixing material

Model: WA 070



WA 080 upright post fixing

Model: WA 080

WA 080 can be used to fix the wall mount enclosure onto upright posts easily, the width of the boxes should be no more than 600mm

Material: sheet steel, galvanized steel

Packing: 2pcs/set per pack(include 4pcs nuts & bolts)

Accessories Of Wall Mount Enclosure

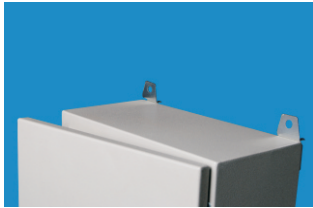

WC010

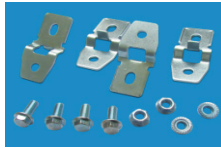

Wall mount bracket : WC 010

Manufactured in 4mm sheet steel zinc plated passivated.
 Pack of 4 pieces with fixing material
 Model: WC 010
 For box model ST,STI,STIP,STIP wall mount enclosure



WTC010



Wall mount bracket: WTC 010

Manufactured in 4mm sheet steel zinc plated passivated
 Pack of 4 pieces with fixing material
 For the box model TB,TL,TBS,TL-G terminal box
 Package:4pcs/set
 Model: WTC 010

Louver plates(ventilation plate)

To be fitted on any surface of the enclosure for internal ventilation. Supply include 1 piece louver plate & fixing material,gasket Colour RAL7032 textured finish

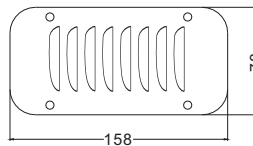

Model: GP-O

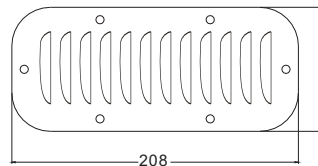

Model: GP-A

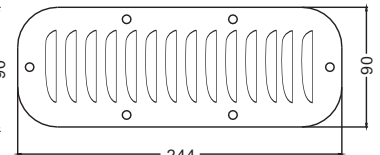

Model: GP-B

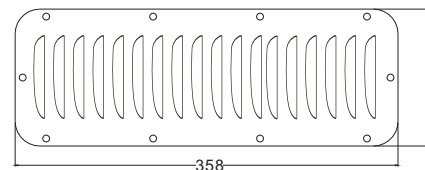

Model: GP-C

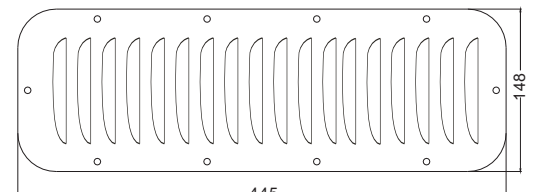

Model: GP-D

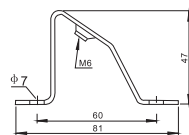

WL02 45° bracket

WL 02 brackets can be used to slope the DIN rails into 45,
 1 pack of 20 pieces
 Model: WL 020

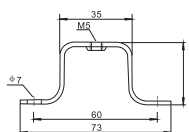
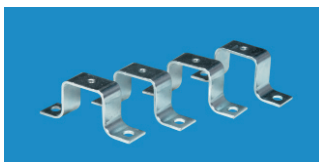

WS02 bracket

WS 02 brackets can be used to upraise the DIN rails,
 1 pack of 20 pieces
 Model: WS 02



MNS Low-voltage withdrawable complete switchgear equipment

Introduction

- 1、 MNS is a modular, multi-purpose low-voltage distribution cabinet. Used in metallurgy, petroleum, chemical, industrial and mining enterprises and infrastructure for all occasions that require high reliability low pressure systems, power distribution and motor control systems.
- 2、 MNS using specific high degree flexibility of cabinet structure. According to customer needs or different occasions, the cabinet can be mounted a variety of models and specifications of components. According to different electrical equipments, Various types of feed units can be mounted in a series of cabinet or a cabinet. Such as: feeder circuits and motor control circuits can be mixed together.
- 3、 MNS is a full range of low voltage switchgear, meet your full range of needs. Used for 1200 A low pressure system.
- 4、 MNS can provide a high level of reliability and security. User-friendly design, enhanced safety for personnel and equipment needed for protection.
- 5、 MNS for the whole assembly structure, Its unique profiles structure and connection and compatibility of the various components
- 6、 Standard: IEC60439.1, GB7251.1

Main features

- 1、 In order to facilitate the installation and on-site construction of equipment no dedicated cable channel in the distribution cabinet, along with the appropriate cable fasteners.
- 2、 Special profile structural and connections to ensure strength of the cabinet.
- 3、 Various locations of drawer unit can positioning accuracy, clear instructions, and can be locked in each position separately.
- 4、 Standardization profiles and universal connector can be assembled without limitation.

Ordering Notice: Please provide the following information

- 1、 All models products include the main circuit number and auxiliary circuit scheme number.
- 2、 Main circuit system sequence diagram
- 3、 Cabinet floor plan
- 4、 Auxiliary circuit electrical schematics
- 5、 Components list inside cabinet
- 6、 voltage, current and time setting parameters in Circuit
- 7、 It is incompatible with the normal use of the product other special requirements



ST series of low-enclosed control box

Introduction

ST series of closed-end distribution box suitable for 50Hz, 660V and below, the load current less than 225A three-phase three-wire, three-phase four-wire, three-phase five-wire system, the distribution system for control, leakage protection and motor overload, short circuit, lack of protection and various control, the box has rational design, small size, beautiful appearance, safe and reliable, widely used in metallurgy, petrochemical, health care, aviation, residential areas, shopping malls, schools, urban renewal, etc.

Ordering Notice: Please specify when ordering

- 1、 Model
- 2、 Installation
- 3、 Structure
- 4、 System Diagram
- 5、 Special requirements can be resolved through consultation Cabinet color (if not indicated, according to the standard color RAL7032)

Electricity Sets



MCC motor control center

Introduction

MOTOR CONTROL CENTER, abbreviation MCC. Motor control centers will unified management of power distribution equipment, will be loaded into a variety of motor control unit, a joint unit feeders, distribution transformers, lighting distribution panels, interlocking relays and metering equipment installed within the cabinet as a whole and by one common enclosed bus powered.

In all areas of the national economy, such as electricity, petroleum, chemical, metallurgy, mining, paper, light industry, automobile, shipbuilding industry, transportation, municipal construction, food and beverage, water treatment, waste disposal, pharmaceutical, motor get more to the more widely used. To make the motor running and reliable operation, the need for a single motor and a unified production line motor control and protection.

Therefore, the level of motor control center MCC has also been developing rapidly. MCC aims to be connected to AC low voltage circuit full motor control and protection equipment, according to certain specifications of the system components assembled into standardized units corresponding specifications of each component controls a motor, this standard cell assemblies loaded into the cabinet to achieve multiple centralized control of the motor.

Suitable Environment

Working temperature: $-10\text{ }^{\circ}\text{C} \sim +55\text{ }^{\circ}\text{C}$
 Storage temperature: $-20\text{ }^{\circ}\text{C} \sim +65\text{ }^{\circ}\text{C}$
 Relative humidity: 5% ~ 95%
 No frost Altitude: $\leq 2500\text{m}$
 Pollution degree: 2
 Protection degree: Ip20
 Installation Level: 111
 Use the occasion: coal, petrochemical, metallurgy, electric power, shipbuilding, and civil construction and other fields.

MCC Superiority motor control center

Using MCC (MOTOR CONTROL CENTER) specialized intelligent management programs, in addition to all the advantages of remote monitoring mode, also reduce the amount of isolation devices, terminal block (box), I/O cards, analog transmitters and so on. And smart devices installed locally, connect with the host computer via a communication line, you can save a lot of control cables, saving a lot of investment and effort to install and maintain, thereby reducing costs. In addition, the function of each device is relatively independent, only connected through the network between the devices, network configuration and flexible

so that a reliable line of the whole system is greatly improved, any device failure affects only the corresponding components will not cause the system to crash. This distributed control system and centralized management of the combined model, its more powerful, with better security, is the main trend of the current metallurgical steel industry electrical automation control.

Ordering Notice: Please provide the following information when ordering.
Model Specifications
Quantity
Primary circuit program
Color (if not required, according to our standard color RAL7032)
Other special requirements



TIBOX[®]
TIANQI ELECTRIC

浙江天齐电气有限公司

ZHEJIANG TIANQI ELECTRIC CO., LTD



国内销售: +86-572-5706666

国际销售: +86-572-5815118

邮箱: marry@tibox.cn

投诉电话: 15355822021

地址: 浙江省湖州市安吉县天子湖工业园区

传真: +86-572-5820333

传真: +86-572-5118861

网址: www.tibox.cn

邮编: 313310